

## ROUND FLAT VACUUM CUPS WITH SUPPORTS

These cups have been designed in particular for handling metal sheets, glass, wooden panels, machined marble and granite and other similar materials.

The shape of their lips allows a firm grip of the surface of the load to be handled, eliminating any oscillation and significantly reducing the air volume contained within, thus allowing quicker grip and release. These cups are provided with cleats which, besides avoiding the load to bend in correspondence of the gripping point, also have the purpose of increasing the friction surface with the vertically lifted load, preventing it from slipping. They are normally available in the three standard compounds but can be supplied in special compounds listed on pg. 31 and in a minimum amount to be defined in the order, upon request.

These cups can be cold fitted with no adhesives onto their anodised aluminium support equipped with a threaded hole in the centre to allow its fastening to the automation and, upon request, can be supplied with a side hole with gas threading for the suction fitting.

These cups are extremely easy to replace; simply request the cup indicated in the table in the desired compound when requesting the spare part.

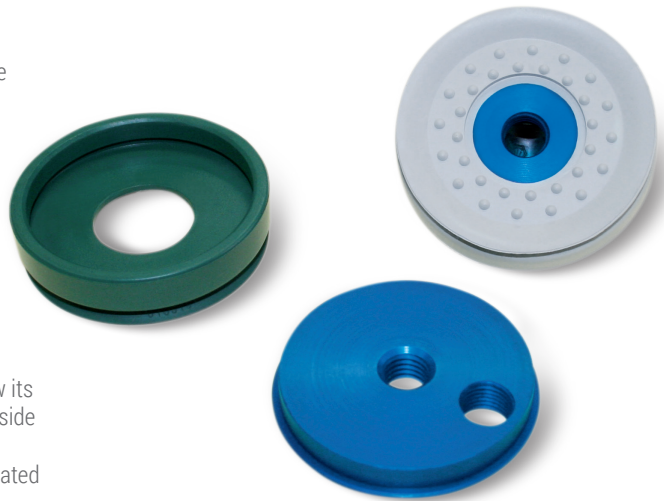

### VACUUM CUPS

Item	Force Kg	Volume cm <sup>3</sup>	A Ø	B Ø	C Ø	D Ø	E	F	H	M	N Ø	O Ø
01 65 15 *	8.29	9.1	68	63	59	65	3	7	17	--	27	--
01 65 16 *	8.29	9.1	68	63	59	65	3	7	17	21	27	4.5

\* Complete the code indicating the compound: A= oil-resistant rubber; N= natural para rubber; S= silicone

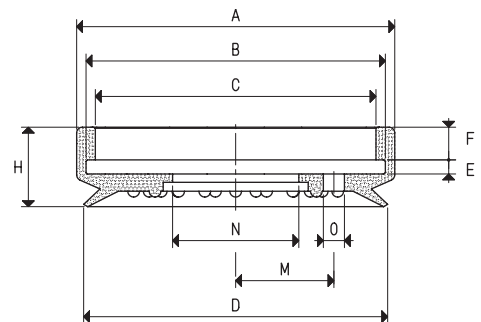

### SUPPORTS

Item	A Ø	B Ø	C Ø	D Ø	E	H	M	For vacuum cup item	Support material	Weight g
00 08 32	60	M12	--	64	3	10	--	01 65 15	aluminium	80.6
00 08 424	60	G1/4"	--	64	3	10	--	01 65 15	aluminium	80.6
00 02 36	60	M8	G1/4"	64	3	10	21	01 65 16	aluminium	78.1
00 06 13	60	M12	G1/4"	64	3	10	21	01 65 16	aluminium	77.1

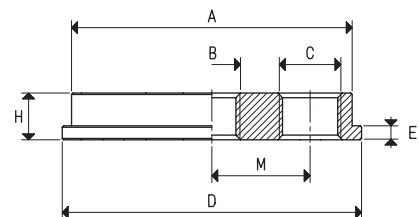

### VACUUM CUPS WITH SUPPORT

Item	Force Kg	A Ø	B Ø	C Ø	D Ø	F	H	M	O Ø	Vacuum cup item	Support item	Weight g
08 65 15 *	8.29	69	M12	--	65	10	17	--	--	01 65 15	00 08 32	102.0
08 65 15 1/4" *	8.29	69	G1/4"	--	65	10	17	--	--	01 65 15	00 08 424	102.0
08 65 16 *	8.29	69	M8	G1/4"	65	10	17	21	4.5	01 65 16	00 02 36	100.0
08 65 17 *	8.29	69	M12	G1/4"	65	10	17	21	4.5	01 65 16	00 06 13	98.5

\* Complete the code indicating the compound: A= oil-resistant rubber; N= natural para rubber; S= silicone

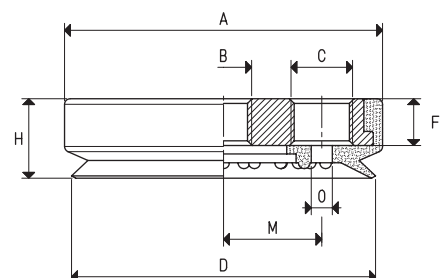



### VACUUM CUPS

Item	Force Kg	Volume cm <sup>3</sup>	A Ø	B Ø	C Ø	D Ø	E	F	H	M	N Ø	O Ø
<b>01 85 15 *</b>	14.18	13.0	68	63	59	85	3	7	17	--	27	--
<b>01 85 16 *</b>	14.18	13.0	68	63	59	85	3	7	17	21	27	4.5

\* Complete the code indicating the compound: A= oil-resistant rubber; N= natural para rubber; S= silicone

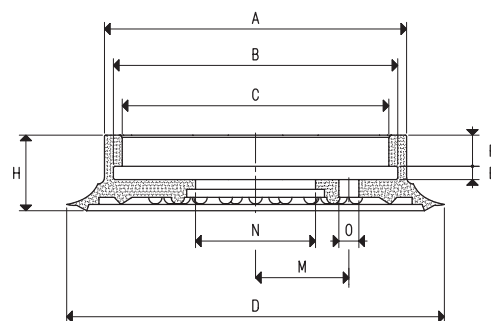

### SUPPORTS

Item	A Ø	B Ø	C Ø	D Ø	E	H	M	For vacuum cup item	Support material	Weight g
<b>00 08 32</b>	60	M12	--	64	3	10	--	01 85 15	aluminium	80.6
<b>00 08 234</b>	60	G1/2"	--	64	3	10	--	01 85 15	aluminium	78.3
<b>00 08 424</b>	60	G1/4"	--	64	3	10	--	01 85 15	aluminium	80.6
<b>00 08 233</b>	60	G3/4"	--	64	3	10	--	01 85 15	aluminium	77.3
<b>00 02 36</b>	60	M8	G1/4"	64	3	10	21	01 85 16	aluminium	78.1
<b>00 06 13</b>	60	M12	G1/4"	64	3	10	21	01 85 16	aluminium	77.1

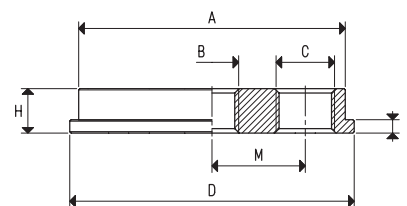

### VACUUM CUPS WITH SUPPORT

Item	Force Kg	A Ø	B Ø	C Ø	D Ø	F	H	M	O Ø	Vacuum cup item	Support item	Weight g
<b>08 85 15 *</b>	14.18	69	M12	--	85	10	17	--	--	01 85 15	00 08 32	110.3
<b>08 85 15 1/2" *</b>	14.18	69	G1/2"	--	85	10	17	--	--	01 85 15	00 08 234	108.0
<b>08 85 15 1/4" *</b>	14.18	69	G1/4"	--	85	10	17	--	--	01 85 15	00 08 424	107.0
<b>08 85 15 3/4" *</b>	14.18	69	G3/4"	--	85	10	17	--	--	01 85 15	00 08 233	107.0
<b>08 85 16 *</b>	14.18	69	M8	G1/4"	85	10	17	21	4.5	01 85 16	00 02 36	107.7
<b>08 85 17 *</b>	14.18	69	M12	G1/4"	85	10	17	21	4.5	01 85 16	00 06 13	106.7

\* Complete the code indicating the compound: A= oil-resistant rubber; N= natural para rubber; S= silicone

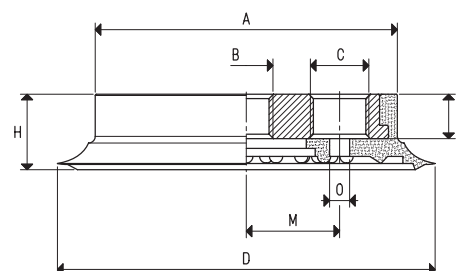

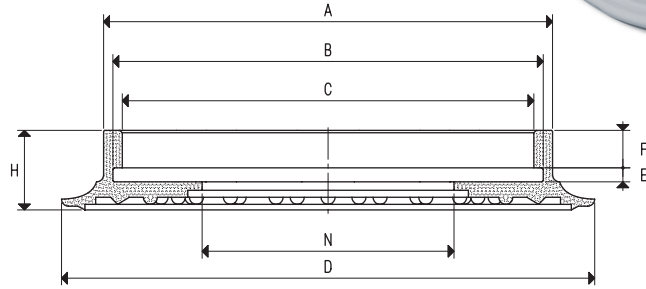
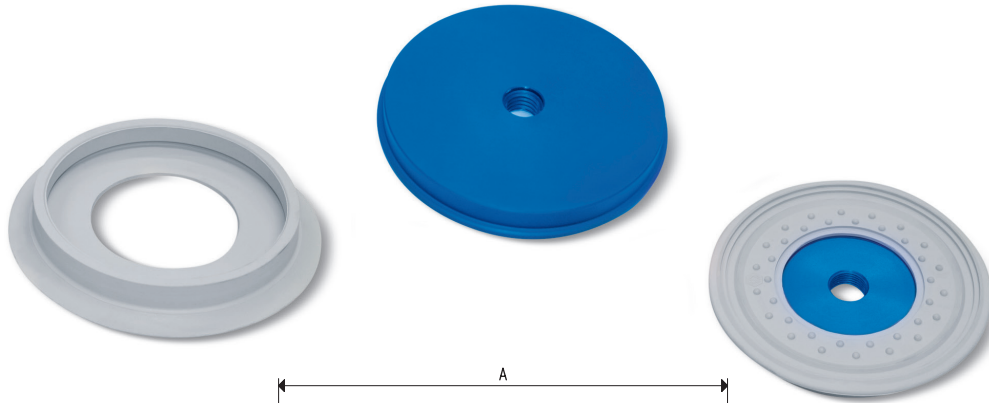

### VACUUM CUP

Item	Force Kg	Volume cm <sup>3</sup>	A Ø	B Ø	C Ø	D Ø	E	F	H	N Ø
<b>01 110 10 *</b>	23.74	24.9	96	91	87	114	3	8	17	54

\* Complete the code indicating the compound: A= oil-resistant rubber; N= natural para rubber; S= silicone

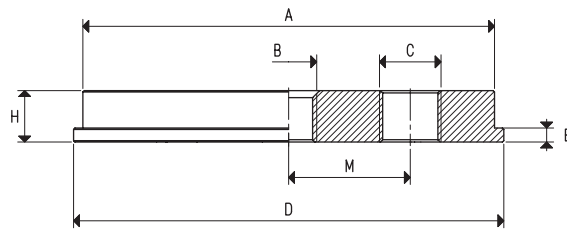

### SUPPORTS

Item	A Ø	B Ø	C Ø	D Ø	E	H	M	For vacuum cup item	Support material	Weight g
<b>00 08 33</b>	88	M12	--	92	3	11	--	01 110 10	aluminium	188.9
<b>00 02 37</b>	88	M8	G1/4"	92	3	11	26	01 110 10	aluminium	188.8
<b>00 06 14</b>	88	M12	G1/4"	92	3	11	26	01 110 10	aluminium	185.8
<b>00 08 123</b>	88	G3/8"	--	92	3	11	--	01 110 10	aluminium	186.1

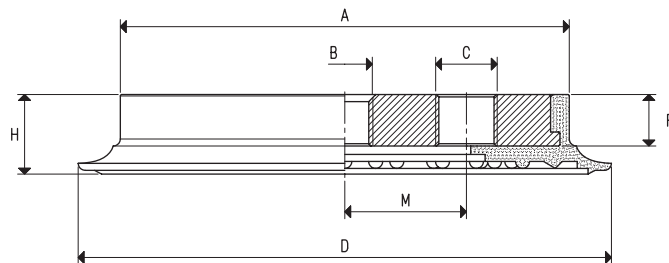

### VACUUM CUPS WITH SUPPORT

Item	Force Kg	A Ø	B Ø	C Ø	D Ø	F	H	M	Vacuum cup item	Support item	Weight g
<b>08 110 10 *</b>	23.74	97	M12	--	114	11	17	--	01 110 10	00 08 33	233.2
<b>08 110 11 *</b>	23.74	97	M8	G1/4"	114	11	17	26	01 110 10	00 02 37	233.1
<b>08 110 12 *</b>	23.74	97	M12	G1/4"	114	11	17	26	01 110 10	00 06 14	230.1
<b>08 110 13 *</b>	23.74	97	G3/8"	--	114	11	17	--	01 110 10	00 08 123	230.4

\* Complete the code indicating the compound: A= oil-resistant rubber; N= natural para rubber; S= silicone

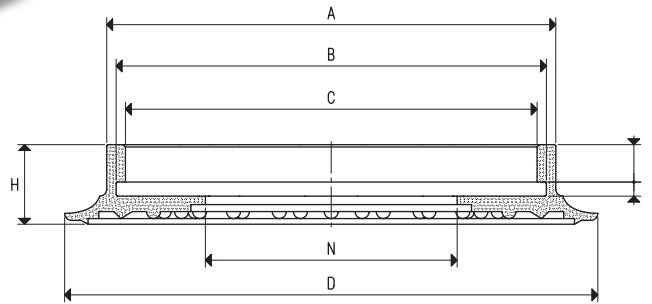

### VACUUM CUP

Item	Force Kg	Volume cm <sup>3</sup>	A Ø	B Ø	C Ø	D Ø	E	F	H	N Ø
<b>01 150 10 *</b>	45.00	75.7	133	125	118	154	4	11	23	64

\* Complete the code indicating the compound: A= oil-resistant rubber; N= natural para rubber; S= silicone

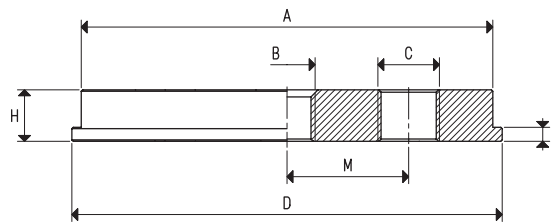

### SUPPORTS

Item	A Ø	B Ø	C Ø	D Ø	E	H	M	For vacuum cup item	Support material	Weight g
<b>00 08 35</b>	120	M12	--	127	4	15	--	01 150 10	aluminium	471.3
<b>00 08 107</b>	120	M12	G3/8"	127	4	15	30	01 150 10	aluminium	476.9
<b>00 08 119</b>	120	G3/8"	--	127	4	15	--	01 150 10	aluminium	478.9
<b>00 08 145</b>	120	G3/8"	G3/8"	127	4	15	27	01 150 10	aluminium	471.9
<b>00 06 15</b>	120	M12	G1/4"	127	4	15	30	01 150 10	aluminium	476.3

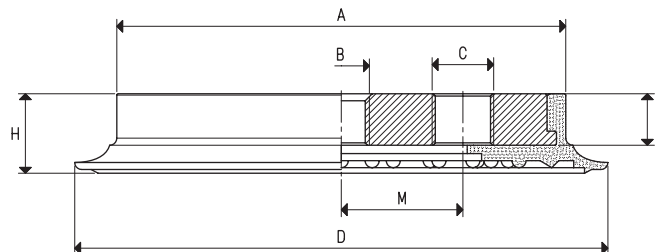

### VACUUM CUPS WITH SUPPORT

Item	Force Kg	A Ø	B Ø	C Ø	D Ø	F	H	M	Vacuum cup item	Support item	Weight g
<b>08 150 10 *</b>	45.00	135	M12	--	154	15	23	--	01 150 10	00 08 35	583.3
<b>08 150 12 *</b>	45.00	135	M12	G3/8"	154	15	23	30	01 150 10	00 08 107	588.9
<b>08 150 13 *</b>	45.00	135	G3/8"	--	154	15	23	--	01 150 10	00 08 119	590.9
<b>08 150 14 *</b>	45.00	135	G3/8"	G3/8"	154	15	23	27	01 150 10	00 08 145	583.9
<b>08 150 16 *</b>	45.00	135	M12	G1/4"	154	15	23	30	01 150 10	00 06 15	588.3

\* Complete the code indicating the compound: A= oil-resistant rubber; N= natural para rubber; S= silicone