

SCHNELLVERSCHRAUBUNGEN TYP 300 UND TYP 400

PUSH-ON FITTINGS TYPE 300 AND 400

FEATURES

- Messingverschraubungen
- Korrosionsschutz durch Vernickelung
- für verschiedenste Anwendungsmöglichkeiten
- drehbare Verschraubungen, Schwenkverschraubungen
- teilweise O-Ring-Abdichtung
- für Schlauchdurchmesser von 4 bis 12 mm
- Brass fittings
- Nickel-plated for corrosion protection
- For various applications
- Rotating fittings, tilting fittings
- O-ring seal in parts
- For tube diameters from 4 mm to 12 mm

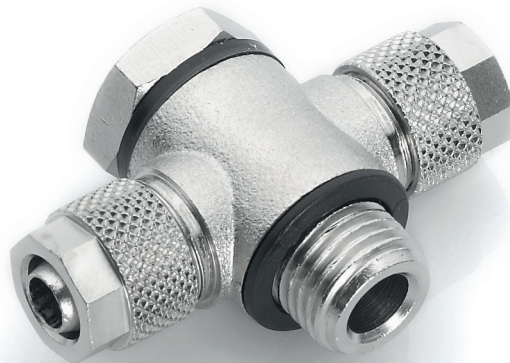



PUSH-ON FITTINGS TYPE 300 AND 400

TECHNISCHE DATEN

| | | |
|--------------------|---|---|
| Betriebstemperatur | -20°C bis +80°C (NBR-Dtg.) -20°C bis +70°C (PVC-Dtg.) | abhängig von den Temperatureigenschaften des Schlauches |
| Betriebsdruck | bis 20 bar | abhängig vom Druckbereich des eingesetzten Schlauches |
| Werkstoffe | Körper und Überwurfmutter Messing vernickelt O-Ringe aus NBR Dichtungen aus PVC | CW614N und CW617N |
| Gewinde | zyl. Gew. DIN EN ISO 228 kon. Gew. DIN EN 10226 (DIN 2999) metr. Gew. DIN ISO 262 | zylindrisch mit O-Ring-Abdichtung |
| Medium | pneumatische, ölhydraulische und hydraulische Kreisläufe | |
| Schläuche | geeignet für diverse Kunststoffschläuche | auch für PVU synthesefadenarmiert |

TECHNICAL DATA

| | | |
|------------------------------|--|---|
| <i>Operating temperature</i> | <i>-20°C up to +80°C (NBR-Sealing) -20°C up to +70°C (PVC-Sealing)</i> | <i>Dependent on the tube's temperature</i> |
| <i>Operating pressure</i> | <i>Up to 20 bar</i> | <i>Dependent on the pressure range of the tube used</i> |
| <i>Materials</i> | <i>Body and swivel nut, brass, nickel-plated NBR O-rings PVC seals</i> | <i>CW614N and CW617N</i> |
| <i>Thread</i> | <i>Cyl. thread, DIN EN ISO 228 Con. thread, DIN EN 10226 (DIN 2999) Met. Thread, DIN ISO 262</i> | <i>Cylindrical with O-ring seal</i> |
| <i>Medium</i> | <i>Pneumatic, oil-hydraulic and hydraulic circuits</i> | |
| <i>Tubes</i> | <i>Suitable for various plastic tubes</i> | <i>Also for reinforced PVU synthetic fibres</i> |

301

Gerade Einschraubverschraubung kon.
Straight male adaptor (con.)

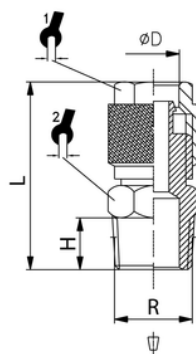

| ITV | ØD | R | H | L | ⊘ | ⊘ |
|-------|---------|------|------|------|----|----|
| 10003 | 4/2,7 | R1/8 | 7,5 | 23 | 8 | 12 |
| 10004 | 5/3 | R1/8 | 7,5 | 23 | 8 | 12 |
| 10005 | 6/4 | R1/8 | 7,5 | 25,5 | 10 | 12 |
| 10006 | 6/4 | R1/4 | 11 | 27 | 10 | 14 |
| 10007 | 8/6 | R1/8 | 7,5 | 27 | 12 | 14 |
| 10008 | 8/6 | R1/4 | 11 | 31 | 12 | 14 |
| 10009 | 8/6 | R3/8 | 11,5 | 31,5 | 12 | 17 |
| 10010 | 8/6 | R1/2 | 14 | 34 | 12 | 22 |
| 10011 | 10/8 | R1/8 | 7,5 | 29 | 14 | 14 |
| 10012 | 10/8 | R1/4 | 11 | 33 | 14 | 14 |
| 10013 | 10/8 | R3/8 | 11,5 | 33,5 | 14 | 17 |
| 10014 | 10/8 | R1/2 | 14 | 36,5 | 14 | 22 |
| 10015 | 12/10 | R3/8 | 11,5 | 35 | 15 | 17 |
| 10016 | 12/10 | R1/2 | 14 | 38 | 15 | 22 |
| 10017 | 15/12,5 | R1/2 | 14 | 40 | 22 | 22 |

301 dk

Gerade Einschraubverschraubung drehbar konisch
Swivel straight taper adaptor

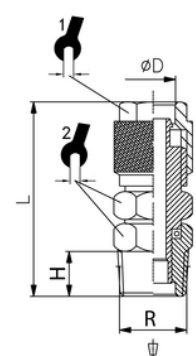

| ITV | ØD | R | H | L | ⊘ | ⊘ | ⊘ |
|-------|-------|------|------|------|----|----|----|
| 10101 | 6/4 | R1/8 | 7,5 | 32,5 | 10 | 12 | 13 |
| 10102 | 6/4 | R1/4 | 11 | 38,0 | 10 | 14 | 15 |
| 10103 | 8/6 | R1/8 | 7,5 | 32,5 | 12 | 12 | 13 |
| 10104 | 8/6 | R1/4 | 11 | 38,0 | 12 | 14 | 15 |
| 10105 | 10/8 | R1/4 | 11 | 40,0 | 14 | 14 | 15 |
| 10106 | 12/10 | R3/8 | 11,5 | 42,0 | 15 | 17 | 17 |

301 dz

Gerade Einschraubverschraubung drehbar, zyl. mit O-Ring
Swivel straight parallel adaptor with o-ring

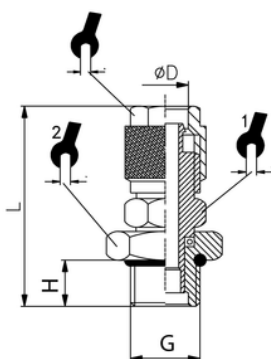

| ITV | ØD | G | H | L | ⊘ | ⊘ | ⊘ |
|-------|-------|------|---|------|----|----|----|
| 10151 | 6/4 | G1/8 | 6 | 32,0 | 10 | 12 | 13 |
| 10152 | 6/4 | G1/4 | 7 | 35,5 | 10 | 14 | 16 |
| 10154 | 8/6 | G1/8 | 6 | 32,0 | 12 | 12 | 13 |
| 10155 | 8/6 | G1/4 | 8 | 36,0 | 12 | 14 | 16 |
| 10156 | 10/8 | G1/4 | 8 | 38,0 | 14 | 14 | 16 |
| 10157 | 12/10 | G3/8 | 9 | 41,0 | 15 | 17 | 18 |

301 z

Gerade Einschraubverschraubung zyl. mit O-Ring
Straight male adaptor cyl. with O-Ring

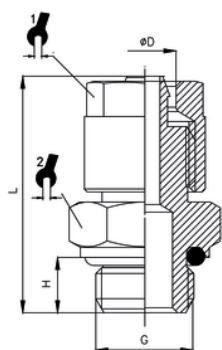

| ITV | ØD | G | H | L | I | I |
|-------|---------|------|-----|------|----|----|
| 10202 | 4/2,7 | M5 | 4 | 19,5 | 7 | 8 |
| 10224 | 4/2,7 | G1/8 | 6 | 25 | 7 | 13 |
| 10203 | 4,3/3 | M5 | 4 | 20 | 8 | 8 |
| 10204 | 4,3/3 | G1/8 | 6 | 25 | 8 | 13 |
| 10205 | 5/3 | M5 | 4 | 20 | 8 | 8 |
| 10207 | 5/3 | G1/8 | 5,5 | 23,5 | 8 | 13 |
| 10208 | 6/4 | M5 | 4 | 20 | 9 | 8 |
| 10209 | 6/4 | G1/8 | 5,5 | 23,5 | 10 | 13 |
| 10210 | 6/4 | G1/4 | 6,5 | 25,5 | 10 | 16 |
| 10211 | 6/4 | G3/8 | 9 | 28 | 10 | 19 |
| 10225 | 6/4 | G1/2 | 10 | 30 | 10 | 24 |
| 10212 | 8/6 | G1/8 | 5,5 | 23 | 12 | 14 |
| 10213 | 8/6 | G1/4 | 6,5 | 25,5 | 12 | 16 |
| 10214 | 8/6 | G3/8 | 9 | 28 | 12 | 19 |
| 10215 | 8/6 | G1/2 | 10 | 30 | 12 | 24 |
| 10226 | 10/8 | G1/8 | 5,5 | 26,5 | 14 | 14 |
| 10216 | 10/8 | G1/4 | 6,5 | 28,5 | 14 | 16 |
| 10217 | 10/8 | G3/8 | 9 | 30 | 14 | 19 |
| 10218 | 10/8 | G1/2 | 10 | 32 | 14 | 24 |
| 10222 | 12/9 | G1/4 | 8 | 31 | 15 | 17 |
| 10223 | 12/9 | G3/8 | 9 | 32,5 | 15 | 19 |
| 10219 | 12/10 | G3/8 | 9 | 30,5 | 15 | 19 |
| 10220 | 12/10 | G1/2 | 10 | 32,5 | 15 | 24 |
| 10221 | 15/12,5 | G1/2 | 10 | 34,5 | 22 | 24 |

302

Manometerschraubung
Straight female adaptor

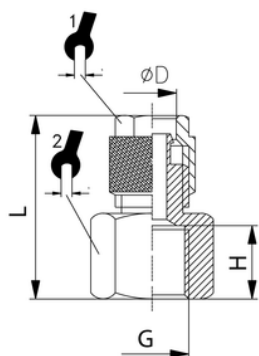
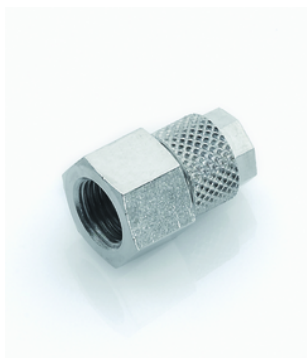

| ITV | ØD | G | H | L | I | I |
|-------|-------|------|------|------|----|----|
| 10302 | 6/4 | G1/8 | 8,5 | 22,5 | 10 | 14 |
| 10303 | 6/4 | G1/4 | 11 | 26 | 10 | 17 |
| 10304 | 6/4 | G3/8 | 11,5 | 27 | 10 | 22 |
| 10314 | 6/4 | G1/2 | 11 | 26,5 | 10 | 24 |
| 10305 | 8/6 | G1/8 | 7,5 | 22,5 | 12 | 14 |
| 10306 | 8/6 | G1/4 | 11 | 26 | 12 | 17 |
| 10307 | 8/6 | G3/8 | 11,5 | 27 | 12 | 22 |
| 10308 | 8/6 | G1/2 | 15 | 30 | 12 | 24 |
| 10310 | 10/8 | G1/4 | 11 | 30 | 14 | 17 |
| 10311 | 10/8 | G3/8 | 11,5 | 28,5 | 14 | 22 |
| 10312 | 10/8 | G1/2 | 15 | 32 | 14 | 24 |
| 10313 | 12/10 | G3/8 | 11,5 | 29 | 15 | 22 |

302 f

Manometer-Schottverschraubung
Straight female adaptor (special)

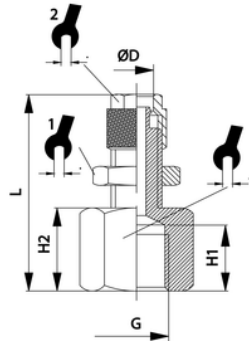

| ITV | ØD | G | H1 | H2 | L | ⌀ | ⌀ | ⌀ |
|-------|------|------|------|------|------|----|----|----|
| 10520 | 5/3 | M5 | 4,5 | 8 | 29 | 10 | 10 | 8 |
| 10521 | 6/4 | G1/8 | 8 | 12 | 38 | 14 | 14 | 10 |
| 10522 | 8/6 | G1/8 | 8 | 12 | 39 | 17 | 17 | 12 |
| 10523 | 8/6 | G1/4 | 12 | 18 | 45 | 17 | 17 | 12 |
| 10525 | 8/6 | G3/8 | 12 | 19 | 46 | 22 | 17 | 12 |
| 10524 | 12/9 | G1/4 | 12 | 18 | 47 | 19 | 19 | 15 |
| 10526 | 12/9 | G3/8 | 11,5 | 13,5 | 42,5 | 19 | 19 | 15 |

303

Gerader Verbinder
Straight connector

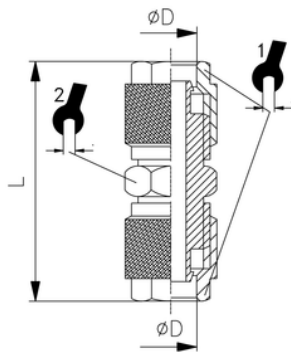

| ITV | ØD | L | ⌀ | ⌀ |
|-------|----------|------|----|----|
| 10403 | 4/2,7 | 27,5 | 7 | 8 |
| 10404 | 5/3 | 31,5 | 8 | 10 |
| 10405 | 6/4x5/3 | 32 | 10 | 12 |
| 10406 | 6/4 | 32 | 10 | 12 |
| 10407 | 8/6x6/4 | 35,5 | 12 | 12 |
| 10408 | 8/6 | 35 | 12 | 12 |
| 10409 | 10/8x6/4 | 35,5 | 14 | 14 |
| 10410 | 10/8x8/6 | 37 | 14 | 14 |
| 10411 | 10/8 | 39 | 14 | 14 |
| 10412 | 12/10 | 43 | 15 | 17 |
| 10413 | 15/12,5 | 47 | 22 | 22 |

304

Gerader Schottverbinder
Bulkhead union

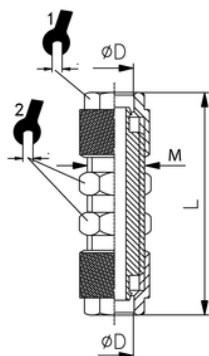

| ITV | ØD | M | L | ⌀ | ⌀ |
|-------|----------|---------|------|----|----|
| 10501 | 4/2,7 | M6x0,5 | 39,5 | 7 | 9 |
| 10502 | 5/3 | M7x0,75 | 39,5 | 8 | 9 |
| 10503 | 6/4x5/3 | M10x1 | 45,5 | 10 | 14 |
| 10504 | 6/4 | M10x1 | 45 | 10 | 14 |
| 10505 | 8/6x6/4 | M12x1 | 47,5 | 12 | 17 |
| 10506 | 8/6 | M12x1 | 48,5 | 12 | 17 |
| 10507 | 10/8x6/4 | M14x1 | 50 | 14 | 17 |
| 10508 | 10/8x8/6 | M14x1 | 51 | 14 | 17 |
| 10509 | 10/8 | M14x1 | 54 | 14 | 17 |
| 10512 | 12/9 | M16x1 | 58 | 15 | 19 |
| 10510 | 12/10 | M16x1 | 57 | 15 | 19 |
| 10511 | 15/12,5 | M20x1 | 59 | 22 | 24 |

305

Winkeleinschraubverschraubung konisch
Elbow male adaptor con.

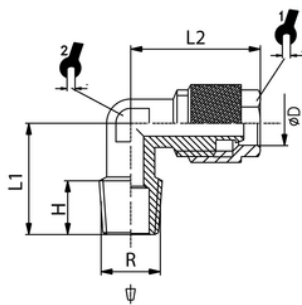

| ITV | ØD | R | H | L1 | L2 | ∅ | ∅ |
|-------|---------|------|------|------|------|----|----|
| 11001 | 5/3 | R1/8 | 7,5 | 15 | 18,5 | 8 | 8 |
| 11003 | 6/4 | R1/8 | 8,5 | 17 | 21 | 10 | 8 |
| 11004 | 6/4 | R1/4 | 11 | 19 | 20,5 | 10 | 8 |
| 11006 | 8/6 | R1/8 | 8,5 | 17 | 20 | 12 | 9 |
| 11007 | 8/6 | R1/4 | 11 | 19 | 22 | 12 | 9 |
| 11008 | 8/6 | R3/8 | 11 | 21 | 21 | 12 | 9 |
| 11009 | 8/6 | R1/2 | 14 | 28 | 23,5 | 12 | 16 |
| 11010 | 10/8 | R1/8 | 7,5 | 18 | 24 | 14 | 11 |
| 11011 | 10/8 | R1/4 | 11 | 22 | 24 | 14 | 11 |
| 11012 | 10/8 | R3/8 | 11,5 | 22 | 25,5 | 14 | 11 |
| 11013 | 10/8 | R1/2 | 14 | 28,5 | 23,5 | 14 | 16 |
| 11014 | 12/10 | R3/8 | 11,5 | 22,5 | 27 | 15 | 13 |
| 11015 | 12/10 | R1/2 | 14 | 28 | 27 | 15 | 16 |
| 11016 | 15/12,5 | R1/2 | 14 | 28 | 31,5 | 22 | 16 |

305 dk

Winkeleinschraubverschraubung kon.
Swivel elbow male adaptor con.

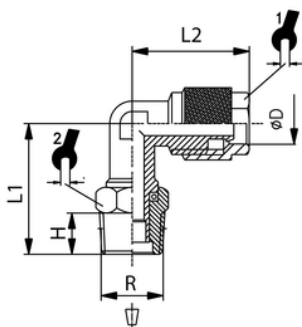

| ITV | ØD | R | H | L1 | L2 | ∅ | ∅ |
|-------|------|------|-----|------|------|----|----|
| 11101 | 6/4 | R1/8 | 7,5 | 22,5 | 20,5 | 10 | 13 |
| 11102 | 6/4 | R1/4 | 11 | 28 | 20,5 | 10 | 15 |
| 11103 | 8/6 | R1/8 | 7,5 | 22,5 | 21 | 12 | 13 |
| 11104 | 8/6 | R1/4 | 11 | 28 | 21 | 12 | 15 |
| 11105 | 10/8 | R1/4 | 11 | 29,5 | 23 | 14 | 15 |

305 dz

Winkelschwenkverschraubung zyl. mit O-Ring
Swivel elbow adaptor with o-ring, cyl.

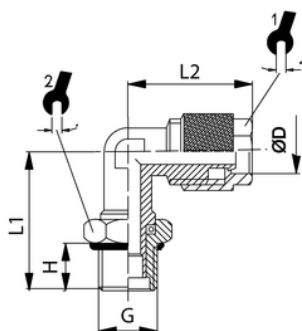

| ITV | ØD | G | H | L1 | L2 | ∅ | ∅ |
|-------|------|------|-----|------|----|----|----|
| 11151 | 6/4 | G1/8 | 5,5 | 21,5 | 19 | 10 | 13 |
| 11152 | 6/4 | G1/4 | 6,5 | 23 | 19 | 10 | 16 |
| 11153 | 8/6 | G1/8 | 6 | 24 | 21 | 12 | 13 |
| 11154 | 8/6 | G1/4 | 6,5 | 23,5 | 21 | 12 | 16 |
| 11155 | 10/8 | G1/4 | 8 | 27,5 | 23 | 14 | 16 |

305 f

Winkelaufschraubverschraubung
Elbow female adaptor

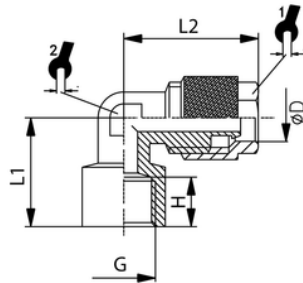

| ITV | ØD | G | H | L1 | L2 | ∠ | ∠ |
|-------|------|------|------|----|------|----|----|
| 11201 | 5/3 | G1/8 | 7,5 | 18 | 20,5 | 8 | 8 |
| 11202 | 6/4 | G1/8 | 7,5 | 18 | 20,5 | 10 | 8 |
| 11203 | 6/4 | G1/4 | 11 | 21 | 21 | 10 | 9 |
| 11204 | 8/6 | G1/8 | 7,5 | 19 | 22 | 12 | 9 |
| 11205 | 8/6 | G1/4 | 11 | 21 | 23,5 | 12 | 9 |
| 11206 | 10/8 | G1/4 | 11 | 22 | 25,5 | 14 | 11 |
| 11207 | 10/8 | G3/8 | 11,5 | 25 | 25,5 | 14 | 14 |

306

Winkerverbinder
Elbow connector

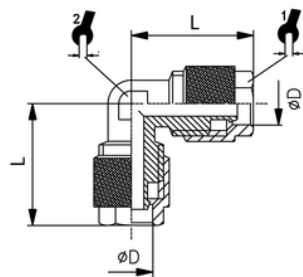

| ITV | ØD | L | ∠ | ∠ |
|-------|---------|------|----|----|
| 11302 | 5/3 | 20,5 | 8 | 8 |
| 11303 | 6/4 | 20,5 | 10 | 8 |
| 11304 | 8/6x6/4 | 22 | 12 | 9 |
| 11305 | 8/6 | 22 | 12 | 9 |
| 11306 | 10/8 | 25,5 | 14 | 11 |
| 11307 | 12/10 | 27 | 15 | 13 |
| 11308 | 15/12,5 | 33,5 | 22 | 16 |

307

T-Einschraubverschraubung konisch
Central t-adaptor, con.

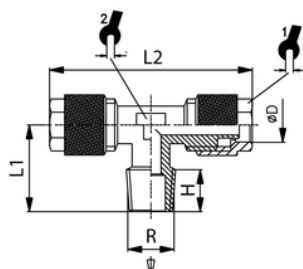

| ITV | ØD | R | H | L1 | L2 | ∠ | ∠ |
|-------|---------|------|------|------|----|----|----|
| 12002 | 5/3 | R1/8 | 7,5 | 15 | 37 | 8 | 8 |
| 12003 | 6/4 | R1/8 | 7,5 | 15 | 37 | 10 | 8 |
| 12004 | 6/4 | R1/4 | 11 | 19 | 41 | 10 | 9 |
| 12006 | 8/6 | R1/8 | 7,5 | 16,5 | 40 | 12 | 9 |
| 12007 | 8/6 | R1/4 | 11 | 20,5 | 44 | 12 | 9 |
| 12008 | 8/6 | R3/8 | 11,5 | 20,5 | 45 | 12 | 12 |
| 12009 | 10/8 | R1/8 | 7,5 | 18 | 48 | 14 | 11 |
| 12010 | 10/8 | R1/4 | 11 | 22 | 48 | 14 | 11 |
| 12011 | 10/8 | R3/8 | 11,5 | 22 | 51 | 14 | 11 |
| 12013 | 12/10 | R3/8 | 11,5 | 22 | 51 | 15 | 13 |
| 12015 | 15/12,5 | R1/2 | 14 | 28 | 63 | 22 | 16 |

307 dk

T-Einschraubverschraubung drehbar konisch
Central t-adaptor, con.

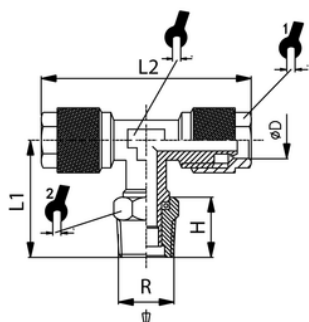

| ITV | ØD | R | H | L1 | L2 | 1 | 2 | 3 |
|-------|------|------|-----|------|----|----|----|----|
| 12101 | 6/4 | R1/8 | 7,5 | 21,5 | 41 | 8 | 10 | 12 |
| 12102 | 6/4 | R1/4 | 11 | 25 | 41 | 9 | 10 | 14 |
| 12103 | 8/6 | R1/8 | 7,5 | 22 | 43 | 9 | 12 | 12 |
| 12104 | 8/6 | R1/4 | 11 | 25,5 | 43 | 9 | 12 | 14 |
| 12105 | 10/8 | R1/4 | 11 | 27 | 48 | 11 | 14 | 14 |

307 dz

T-Einschraubverschraubung drehbar zyl. mit O-Ring
Rotary t-adaptor with o-ring, cyl.

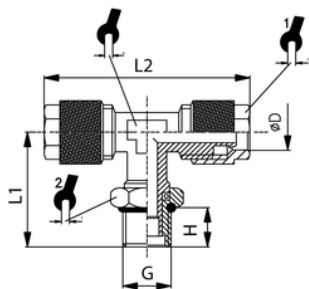

| ITV | ØD | G | H | L1 | L2 | 1 | 2 | 3 |
|-------|------|------|---|------|----|----|----|----|
| 12151 | 6/4 | G1/8 | 6 | 22,5 | 39 | 8 | 8 | 13 |
| 12152 | 6/4 | G1/4 | 8 | 26 | 39 | 9 | 8 | 16 |
| 12153 | 8/6 | G1/8 | 6 | 24 | 40 | 12 | 9 | 13 |
| 12154 | 8/6 | G1/4 | 8 | 27,5 | 40 | 9 | 9 | 16 |
| 12155 | 10/8 | G1/4 | 8 | 27,5 | 45 | 11 | 11 | 16 |

308

L-Einschraubverschraubung konisch
Off-set t-adaptor, con.

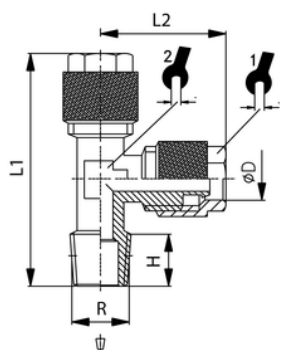

| ITV | ØD | R | H | L1 | L2 | 1 | 2 |
|-------|---------|------|------|------|------|----|----|
| 12202 | 5/3 | R1/8 | 8,5 | 35,5 | 20,5 | 8 | 8 |
| 12203 | 6/4 | R1/8 | 8,5 | 35,5 | 20,5 | 10 | 8 |
| 12204 | 6/4 | R1/4 | 11 | 39 | 20,5 | 10 | 8 |
| 12205 | 8/6 | R1/8 | 8 | 36 | 22 | 12 | 9 |
| 12206 | 8/6 | R1/4 | 11 | 40 | 22 | 12 | 9 |
| 12207 | 8/6 | R3/8 | 12 | 47 | 22 | 12 | 12 |
| 12208 | 10/8 | R1/8 | 7,5 | 38,5 | 25,5 | 14 | 11 |
| 12209 | 10/8 | R1/4 | 12 | 41 | 25,5 | 14 | 11 |
| 12210 | 10/8 | R3/8 | 12 | 41,5 | 25,5 | 14 | 11 |
| 12212 | 12/10 | R3/8 | 12,5 | 45 | 28 | 15 | 13 |
| 12214 | 15/12,5 | R1/2 | 14,5 | 54 | 32,5 | 22 | 16 |

309

T-Verbinder
T-connector

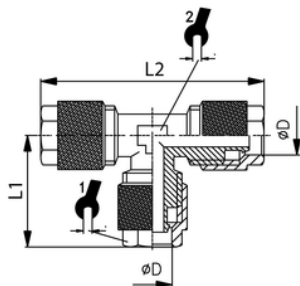

| ITV | ØD | L1 | L2 | h | h |
|-------|----------|------|------|----|----|
| 12300 | 4/2,7 | 19,5 | 38,5 | 7 | 8 |
| 12302 | 5/3 | 20,5 | 41 | 8 | 8 |
| 12303 | 6/4 | 20,5 | 41 | 10 | 8 |
| 12304 | 8/6x6/4 | 20,5 | 44 | 12 | 9 |
| 12305 | 8/6 | 22 | 44 | 12 | 9 |
| 12306 | 10/8x6/4 | 20,5 | 51 | 14 | 11 |
| 12307 | 10/8x8/6 | 22 | 51 | 14 | 11 |
| 12308 | 10/8 | 25,5 | 51 | 14 | 11 |
| 12309 | 12/10 | 28 | 54 | 15 | 13 |
| 12310 | 15/12,5 | 32,5 | 63 | 22 | 16 |

310

Überwurfmutter
Union nut

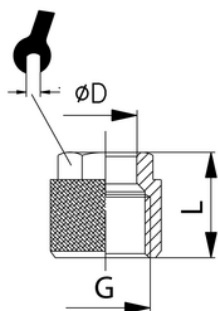

| ITV | ØD | G | L | h |
|-------|---------|---------|------|----|
| 17001 | 4/2,7 | M6x0,5 | 10 | 7 |
| 17002 | 4,3/3 | M7x0,75 | 10 | 8 |
| 17003 | 5/3 | M7x0,75 | 11 | 8 |
| 17004 | 6/4 | M8x0,75 | 11 | 8 |
| 17005 | 6/4 | M10x1 | 11 | 10 |
| 17006 | 8/6 | M12x1 | 11,5 | 12 |
| 17007 | 10/8 | M14x1 | 13,5 | 14 |
| 17008 | 12/10 | M16x1 | 15 | 15 |
| 17009 | 15/12,5 | M20x1 | 16 | 22 |

311

Kreuzverbinder
Cross adaptor

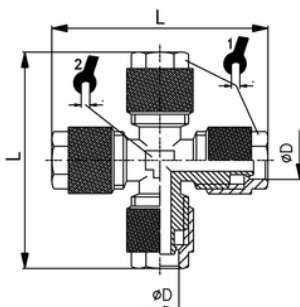

| ITV | ØD | L | h | h |
|-------|---------|------|----|----|
| 13001 | 5/3 | 41,5 | 8 | 8 |
| 13002 | 6/4 | 41,5 | 10 | 8 |
| 13003 | 8/6 | 44,5 | 12 | 9 |
| 13004 | 10/8 | 51 | 14 | 11 |
| 13005 | 12/10 | 58 | 15 | 13 |
| 13006 | 15/12,5 | 64 | 22 | 17 |

312

Knickschutzfeder mit Mutter
Nut + protective spring

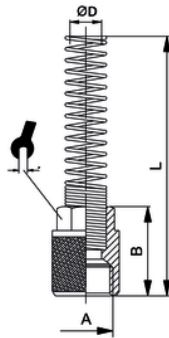

| ITV | ØD | A | B | L | λ |
|-------|-------|-------|----|-----|----|
| 17101 | 6/4 | M10x1 | 18 | 93 | 10 |
| 17102 | 8/6 | M12x1 | 18 | 98 | 12 |
| 17103 | 10/8 | M14x1 | 20 | 105 | 14 |
| 17104 | 12/10 | M16x1 | 22 | 112 | 15 |

313

Einschraubverschraubung kon. mit Knickschutzfeder
Straight male adaptor (con.) + protective spring

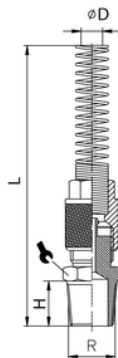

| ITV | ØD | R | H | L | λ |
|-------|-------|------|------|-------|----|
| 10251 | 6/4 | R1/8 | 7,5 | 107,5 | 12 |
| 10252 | 6/4 | R1/4 | 11 | 111,5 | 14 |
| 10253 | 8/6 | R1/8 | 7,5 | 113,5 | 14 |
| 10254 | 8/6 | R1/4 | 11 | 117,5 | 14 |
| 10255 | 8/6 | R3/8 | 11,5 | 118,5 | 17 |
| 10256 | 8/6 | R1/2 | 14 | 120,5 | 22 |
| 10257 | 10/8 | R1/8 | 7,5 | 120,5 | 14 |
| 10258 | 10/8 | R1/4 | 11 | 124,5 | 14 |
| 10259 | 10/8 | R3/8 | 11,5 | 125 | 17 |
| 10260 | 10/8 | R1/2 | 14 | 128 | 22 |
| 10261 | 12/10 | R3/8 | 11,5 | 132 | 17 |
| 10262 | 12/10 | R1/2 | 14 | 135 | 22 |

314

Einschraubverschraubung kon. mit Knickschutzfeder -
drehbar
Straight male swivel adaptor (con.) + protective spring

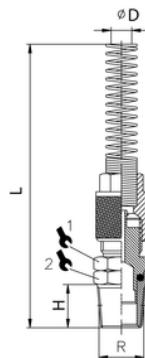

| ITV | ØD | R | H | L | λ | λ |
|-------|-------|------|------|-----|----|----|
| 10263 | 6/4 | R1/8 | 7,5 | 118 | 12 | 12 |
| 10264 | 6/4 | R1/4 | 11 | 122 | 14 | 14 |
| 10265 | 8/6 | R1/8 | 7,5 | 123 | 12 | 12 |
| 10266 | 8/6 | R1/4 | 11 | 127 | 14 | 14 |
| 10267 | 10/8 | R1/4 | 11 | 134 | 14 | 14 |
| 10268 | 12/10 | R3/8 | 11,5 | 142 | 17 | 17 |

315

Einschraubverschraubung zyl. mit Knickschutzfeder -
drehbar mit O-Ring
Straight male swivel adaptor (cyl.) + protective spring

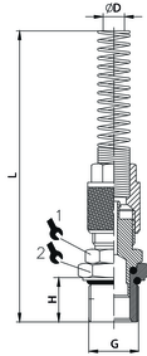

| ITV | ØD | G | H | L | ⌘ | ⌘ |
|-------|-------|------|------|-----|----|----|
| 10271 | 6/4 | G1/8 | 7,5 | 118 | 12 | 13 |
| 10272 | 6/4 | G1/4 | 11 | 122 | 14 | 16 |
| 10273 | 8/6 | G1/8 | 7,5 | 123 | 12 | 13 |
| 10274 | 8/6 | G1/4 | 11 | 127 | 14 | 16 |
| 10275 | 10/8 | G1/4 | 11 | 134 | 14 | 16 |
| 10276 | 12/10 | G3/8 | 11,5 | 142 | 17 | 18 |

316

Einschraubverschraubung zyl. mit Knickschutzfeder mit
O-Ring
Straight male adaptor (cyl.) + protective spring with
O-Ring

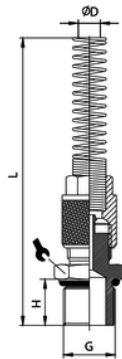

| ITV | ØD | G | H | L | ⌘ |
|-------|-------|------|----|-------|----|
| 10281 | 6/4 | G1/8 | 6 | 106 | 13 |
| 10282 | 6/4 | G1/4 | 8 | 108,5 | 17 |
| 10283 | 6/4 | G3/8 | 9 | 109,5 | 19 |
| 10284 | 6/4 | G1/2 | 10 | 112 | 24 |
| 10285 | 8/6 | G1/8 | 6 | 112 | 14 |
| 10286 | 8/6 | G1/4 | 8 | 114,5 | 17 |
| 10287 | 8/6 | G3/8 | 9 | 115,5 | 19 |
| 10288 | 8/6 | G1/2 | 10 | 116,5 | 24 |
| 10289 | 10/8 | G1/8 | 6 | 119 | 14 |
| 10291 | 10/8 | G1/4 | 8 | 121 | 17 |
| 10292 | 10/8 | G3/8 | 9 | 122,5 | 19 |
| 10293 | 10/8 | G1/2 | 10 | 124 | 24 |
| 10294 | 12/10 | G3/8 | 9 | 129,5 | 19 |
| 10295 | 12/10 | G1/2 | 10 | 131 | 24 |

401

Winkelschwenkverschraubung
Complete single banjo adaptor

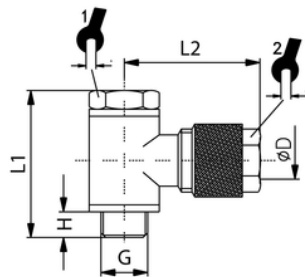

| ITV | ØD | G | H | L1 | L2 | φ | φ |
|--------|---------|------|-----|------|------|----|----|
| S25521 | 4/2,7 | M5 | 3,5 | 23 | 16,5 | 7 | 8 |
| S25523 | 4/2,7 | G1/8 | 6 | 28 | 23 | 7 | 10 |
| S25500 | 4,3/3 | M5 | 3 | 17,5 | 16,0 | 8 | 8 |
| S25518 | 4,3/3 | G1/8 | 6 | 28 | 21 | 14 | 8 |
| S25519 | 5/3 | M5 | 4 | 17,5 | 16,5 | 8 | 8 |
| S25520 | 5/3 | G1/8 | 4 | 28 | 23 | 14 | 8 |
| S25501 | 6/4 | M5 | 4 | 17,5 | 16,5 | 8 | 9 |
| S25502 | 6/4 | G1/8 | 5,5 | 28 | 23 | 14 | 10 |
| S25503 | 6/4 | G1/4 | 8 | 33 | 26 | 17 | 10 |
| S25504 | 6/4 | G3/8 | 9 | 36 | 26 | 19 | 10 |
| S25505 | 8/6 | G1/8 | 5,5 | 28 | 23 | 14 | 12 |
| S25506 | 8/6 | G1/4 | 8 | 33 | 26 | 17 | 12 |
| S25507 | 8/6 | G3/8 | 9 | 36 | 26 | 19 | 12 |
| S25508 | 8/6 | G1/2 | 10 | 42 | 31 | 24 | 12 |
| S25530 | 10/8 | G1/8 | 6 | 28 | 27,5 | 14 | 14 |
| S25509 | 10/8 | G1/4 | 8 | 33 | 29,5 | 17 | 14 |
| S25510 | 10/8 | G3/8 | 9 | 36 | 30,5 | 19 | 14 |
| S25511 | 10/8 | G1/2 | 10 | 42 | 34 | 24 | 14 |
| S25531 | 12/10 | G3/8 | 9 | 36 | 31,5 | 19 | 15 |
| S25512 | 12/10 | G1/2 | 10 | 42 | 35 | 24 | 15 |
| S25513 | 12/9 | G1/4 | 7,5 | 36 | 26 | 17 | 15 |
| S25514 | 12/9 | G3/8 | 8 | 36 | 30 | 19 | 15 |
| S25532 | 15/12,5 | G1/2 | 10 | 42 | 36,5 | 24 | 22 |

402

T-Schwenkverschraubung
Complete double banjo adaptor

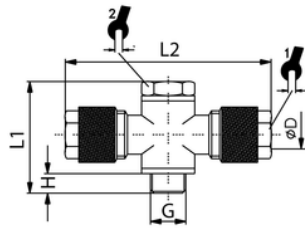

| ITV | ØD | G | H | L1 | L2 | ι | ι |
|--------|---------|------|-----|------|------|----|----|
| S25621 | 4,3/3 | M5 | 4 | 17,5 | 33 | 8 | 8 |
| S25622 | 4,3/3 | G1/8 | 6 | 28 | 46,5 | 8 | 14 |
| S25623 | 5/3 | M5 | 4 | 17,5 | 33 | 8 | 8 |
| S25624 | 5/3 | G1/8 | 4 | 28 | 46,5 | 8 | 14 |
| S25625 | 6/4 | M5 | 4 | 17,5 | 33 | 9 | 8 |
| S25601 | 6/4 | G1/8 | 6 | 28 | 46,5 | 10 | 14 |
| S25602 | 6/4 | G1/4 | 8 | 33 | 50 | 10 | 17 |
| S25603 | 6/4 | G3/8 | 9,5 | 36 | 53,5 | 10 | 19 |
| S25604 | 8/6 | G1/8 | 6 | 28 | 50 | 12 | 14 |
| S25605 | 8/6 | G1/4 | 8 | 33 | 55 | 12 | 17 |
| S25606 | 8/6 | G3/8 | 9,5 | 36 | 55,5 | 12 | 19 |
| S25607 | 8/6 | G1/2 | 10 | 42 | 61 | 12 | 24 |
| S25631 | 10/8 | G1/8 | 6 | 28 | 53 | 14 | 14 |
| S25608 | 10/8 | G1/4 | 8 | 33 | 59 | 14 | 17 |
| S25609 | 10/8 | G3/8 | 9 | 36 | 61 | 14 | 19 |
| S25610 | 10/8 | G1/2 | 10 | 42 | 68 | 14 | 24 |
| S25632 | 12/10 | G3/8 | 9,5 | 36 | 53 | 15 | 19 |
| S25611 | 12/10 | G1/2 | 10 | 42 | 70 | 15 | 24 |
| S25614 | 12/9 | G3/8 | 8 | 31,5 | 66 | 15 | 19 |
| S25633 | 15/12,5 | G1/2 | 10 | 42 | 62 | 22 | 24 |

405

Ringstück 1-fach
Single banjo body

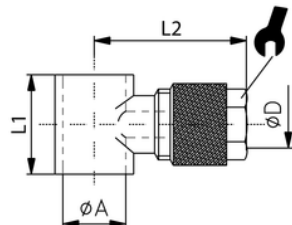

| ITV | ØD | ØA | L1 | L2 | ι |
|-------|---------|------|----|------|----|
| 15002 | 4/2,7 | M5 | 9 | 16 | 8 |
| 15001 | 4/2,7 | G1/8 | 15 | 21 | 8 |
| 15004 | 5/3 | M5 | 9 | 15,5 | 8 |
| 15005 | 5/3 | G1/8 | 15 | 21 | 8 |
| 15006 | 6/4 | M5 | 9 | 16,5 | 9 |
| 15007 | 6/4 | G1/8 | 15 | 21,5 | 10 |
| 15008 | 6/4 | G1/4 | 17 | 24,5 | 10 |
| 15009 | 6/4 | G3/8 | 20 | 26 | 10 |
| 15010 | 8/6 | G1/8 | 15 | 21,5 | 12 |
| 15011 | 8/6 | G1/4 | 17 | 22,5 | 12 |
| 15012 | 8/6 | G3/8 | 20 | 24,5 | 12 |
| 15013 | 8/6 | G1/2 | 24 | 31 | 12 |
| 15014 | 10/8 | G1/8 | 15 | 27,5 | 14 |
| 15015 | 10/8 | G1/4 | 17 | 29,5 | 14 |
| 15016 | 10/8 | G3/8 | 20 | 30,5 | 14 |
| 15017 | 10/8 | G1/2 | 24 | 34 | 14 |
| 15018 | 12/10 | G3/8 | 20 | 31,5 | 15 |
| 15019 | 12/10 | G1/2 | 24 | 35 | 15 |
| 15021 | 12/9 | G1/4 | 20 | 31,5 | 15 |
| 15023 | 12/9 | G3/8 | 20 | 31,5 | 15 |
| 15020 | 15/12,5 | G1/2 | 24 | 36,5 | 22 |

406

Ringstück 2-fach
Double banjo body

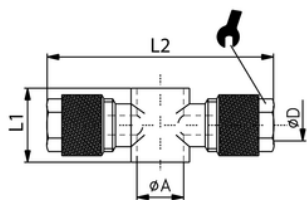

| ITV | ØD | ØA | L1 | L2 | ↳ |
|-------|---------|------|------|------|----|
| 15101 | 4/2,7 | M5 | 12,5 | 39 | 8 |
| 15102 | 4/2,7 | G1/8 | 15 | 46,5 | 8 |
| 15120 | 4,3/3 | M5 | 9 | 33 | 8 |
| 15121 | 4,3/3 | G1/8 | 15 | 46,5 | 8 |
| 15103 | 5/3 | M5 | 9 | 33 | 8 |
| 15104 | 5/3 | G1/8 | 15 | 46,5 | 8 |
| 15105 | 6/4 | M5 | 9 | 33 | 9 |
| 15106 | 6/4 | G1/8 | 15 | 45 | 10 |
| 15107 | 6/4 | G1/4 | 17 | 50,5 | 10 |
| 15108 | 6/4 | G3/8 | 20 | 53,5 | 10 |
| 15109 | 8/6 | G1/8 | 15 | 41 | 12 |
| 15110 | 8/6 | G1/4 | 17 | 49 | 12 |
| 15111 | 8/6 | G3/8 | 20 | 50 | 12 |
| 15112 | 8/6 | G1/2 | 24 | 62,5 | 12 |
| 15113 | 10/8 | G1/8 | 15 | 55 | 14 |
| 15114 | 10/8 | G1/4 | 17 | 59 | 14 |
| 15115 | 10/8 | G3/8 | 20 | 61 | 14 |
| 15116 | 10/8 | G1/2 | 24 | 68 | 14 |
| 15117 | 12/10 | G3/8 | 20 | 63 | 15 |
| 15118 | 12/10 | G1/2 | 24 | 70 | 15 |
| 15122 | 12/9 | G3/8 | 14,5 | 66 | 15 |
| 15119 | 15/12,5 | G1/2 | 24 | 62 | 22 |

407

Hohlschraube 1-fach
Single hollow screw

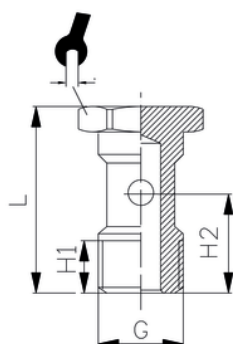

| ITV | G | H1 | H2 | L | ↳ |
|-------|------|------|------|------|----|
| 14101 | M5 | 6 | 9,6 | 17,5 | 8 |
| 14106 | M6 | 7,5 | 10,5 | 19 | 8 |
| 14102 | G1/8 | 6,5 | 15 | 28 | 14 |
| 14403 | G1/4 | 12 | 18 | 33 | 17 |
| 14404 | G3/8 | 13,5 | 21 | 36 | 19 |
| 14405 | G1/2 | 15 | 23,5 | 42 | 24 |

408

Hohlschraube 2-fach
Double hollow screw

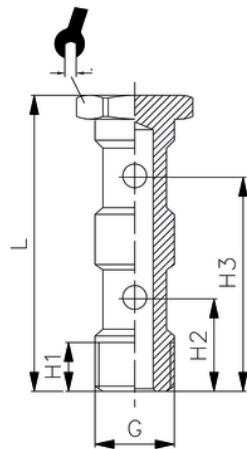

| ITV | G | H1 | H2 | H3 | L | t |
|-------|------|------|------|------|------|----|
| 14202 | G1/8 | 9 | 15 | 31 | 44,5 | 14 |
| 14503 | G1/4 | 11 | 17 | 36 | 51,5 | 17 |
| 14504 | G3/8 | 14 | 20,5 | 43 | 58,1 | 19 |
| 14505 | G1/2 | 15,5 | 23,5 | 49,5 | 68 | 24 |

415

Hohlschraube 3-fach
Triple hollow screw

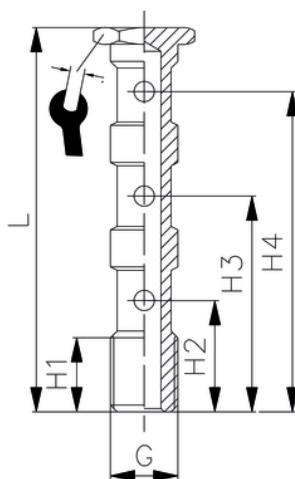

| ITV | G | H1 | H2 | H3 | H4 | L | t |
|-------|------|----|------|----|------|------|----|
| 14301 | G1/8 | 9 | 16 | 32 | 48 | 60 | 14 |
| 14703 | G1/4 | 12 | 18,5 | 37 | 55,5 | 70,5 | 17 |
| 14303 | G3/8 | 13 | 20,5 | 44 | 65 | 80 | 19 |
| 14705 | G1/2 | 16 | 25 | 51 | 70,5 | 94 | 24 |

411

Dichtring PVC-hart schwarz
Sealing ring, black

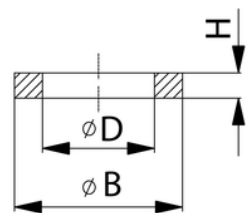

| ITV | ØD | ØB | H | für Gew. |
|--------|------|------|-----|----------|
| 800031 | 5,3 | 7,7 | 1 | M5 |
| 800032 | 10,2 | 13 | 1,5 | G1/8 |
| 800033 | 13,4 | 17,9 | 2 | G1/4 |
| 800034 | 17,1 | 21,8 | 2 | G3/8 |
| 800035 | 21,3 | 26,5 | 2 | G1/2 |
| 800036 | 26,7 | 32,4 | 2 | G3/4 |
| 800037 | 33,5 | 39 | 2 | G1 |

412

Ringstück mit Innengewinde
Female single banjo body

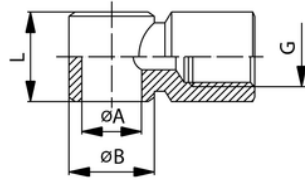

| ITV | G | ØA | ØB | L |
|-------|------|-------|----|----|
| 60901 | M5 | 5 | - | 10 |
| 60902 | G1/8 | 9,9 | 14 | 15 |
| 60903 | G1/4 | 13,5 | 18 | 18 |
| 60904 | G3/8 | 16,75 | 21 | 20 |
| 60905 | G1/2 | 21 | 26 | 24 |

601

Stecknippel-Einschraubverschraubung
Male threaded plug connection

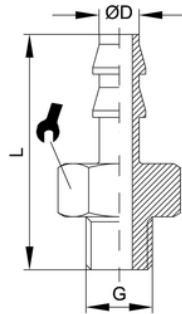

| ITV | ØD | G | L | t |
|--------|----|----|----|---|
| 150001 | 3 | M5 | 17 | 8 |
| 150002 | 4 | M5 | 18 | 8 |

603

Stecknippel-Verbinder
Push-in connector

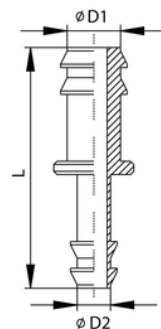

| ITV | ØD1 | ØD2 | L |
|--------|-----|-----|----|
| 150401 | 2 | 2 | 20 |
| 150402 | 3 | 2 | 20 |
| 150403 | 3 | 3 | 20 |
| 150404 | 4 | 3 | 21 |
| 150405 | 4 | 4 | 22 |
| 150406 | 6 | 4 | 22 |
| 150407 | 6 | 6 | 22 |

604

Stecknippel-Winkelverbinder
Push-in elbow connector

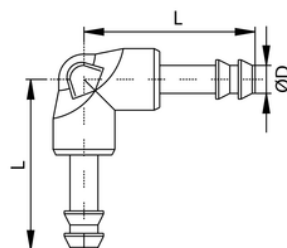

| ITV | ØD | L |
|--------|----|----|
| 151301 | 2 | 16 |
| 151302 | 3 | 16 |
| 151303 | 4 | 22 |
| 151304 | 6 | 22 |

605

Stecknippel-T-Verbinder
Push-in t-connector

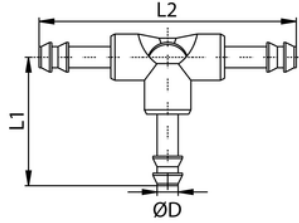

| <i>ITV</i> | <i>ØD</i> | <i>L1</i> | <i>L2</i> |
|------------|-----------|-----------|-----------|
| 152301 | 2 | 16 | 32 |
| 152302 | 3 | 16 | 32 |
| 152303 | 4 | 22 | 44 |
| 152304 | 6 | 22 | 44 |