

## FITTINGS AUS MESSING

### *BRASS FITTINGS*

#### FEATURES

- für verschiedenste Einsatzzwecke
- für Anschlüsse von M5 bis 2"
- mit vernickelter oder blanker Oberfläche
- *For various applications*
- *For connections from M5 to 2"*
- *With nickel-plated or polished surface*



**TECHNISCHE DATEN**

Betriebstemperatur	max. +150°C	
Betriebsdruck	bis 60 bar	
Werkstoffe	Messing vernickelt und blank	CW614N und CW617N
Gewinde	DIN 3852 DIN 3858	
Medium	Luft, Wasser, Öl, Dampf, etc.	

**TECHNICAL DATA**

<i>Operating temperature</i>	<i>Max +150°C</i>	
<i>Operating pressure</i>	<i>Up to 60 bar</i>	
<i>Materials</i>	<i>Brass nickel-plated and polished</i>	<i>CW614N and CW617N</i>
<i>Thread</i>	<i>DIN 3852 DIN 3858</i>	
<i>Medium</i>	<i>Air, water, oil, steam, etc.</i>	

## Doppelnippel, cylindrisch

Doppelnippel, cylindrisch  
Double nipple, cylindrical

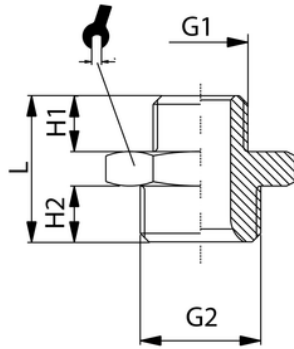

ITV	G1	G2	L	H1	H2	↳
401510	G3/8	G3/4	24	10	9	27
401512	G1/2	G1/2	30	12	12	27
401514	G1/2	G3/4	31	12	12	32
401515	G3/4	G3/4	31	12	12	32
401516	G3/4	G1	35	12	15	41
401518	G1	G1	38	15	15	41
401519	G1 1/4	G1	38	15	15	42
401521	G1 1/4	G1 1/4	38	16	16	42
401520	G1 1/4	G1 1/2	41	16	18	50
401522	G1 1/2	G1 1/2	45	18	18	50
401523	G1 1/2	G2	50	18	22	62
401525	G2	G2	54	22	22	64
401526	G2	G2 1/2	57	22	22	80

## Reduzierung

Reduzierung  
Reducer

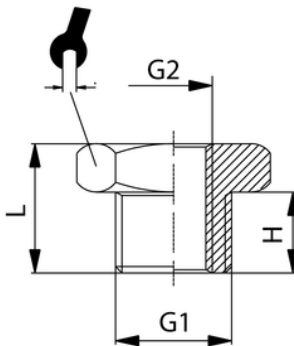

ITV	G1	G2	H	L	↳
401311	G3/4	G1/4	12	19	32
401314	G1	G3/8	15	23	41
401313	G1	G1/2	15	23	41
401312	G1	G3/4	15	23	41
401317	G1 1/4	G1/2	16	23	42
401316	G1 1/4	G3/4	16	23	42
401315	G1 1/4	G1	15	22	42
401320	G1 1/2	G3/4	15,5	22	50
401319	G1 1/2	G1	17	25	50
401318	G1 1/2	G1 1/4	15	23	50
401323	G2	G1	18	26	60
401322	G2	G1 1/4	15	24,5	60
401321	G2	G1 1/2	18	26,5	60

## Stopfen - blank

Stopfen - blank  
Parallel male plug - uncoated

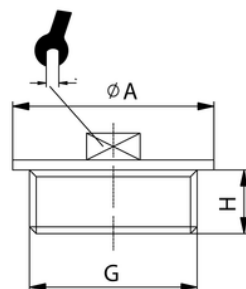

ITV	G	H	ØA	↳
401716	G3/4	8	34	14
401717	G1	9	40	17
401718	G1 1/4	10	52	19
401719	G1 1/2	10	60	22
401720	G2	13	73	24

## Verschlusschraube konisch

vernickelt, Innensechskant ohne Bund  
Male plug conical

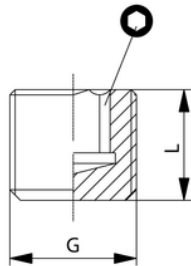

ITV	G	L	Ø
401742	R1/8	8	5
401743	R1/4	10	6
401744	R3/8	11	8
401745	R1/2	13	10
401746	R3/4	15,5	14

## Verschlusschraube zylindrisch

vernickelt, Innensechskant ohne Bund  
Parallel male plug

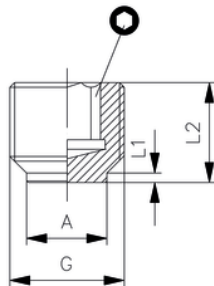

ITV	G	A	L1	L2	Ø
401732	G1/8	8	2	8	5
401733	G1/4	11	3	11	6
401734	G3/8	14,5	3,5	12,5	8
401735	G1/2	16	4	14	10

## Verschluss-Schraube

vernickelt, Innensechskant mit Bund  
Parallel male plug

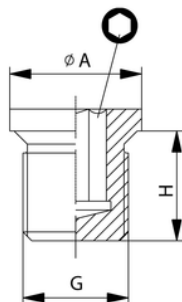

ITV	G	ØA	H	Ø
401752	G1/8	14	8	5
401753	G1/4	18	12	6
401754	G3/8	22	12	8
401755	G1/2	26	10	10
401756	G3/4	31	16	14

## Muffe

Sechskant, vernickelt  
Sleeve - hexagonal, nickel plated

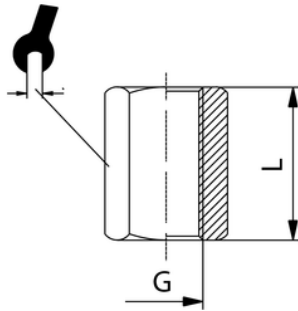
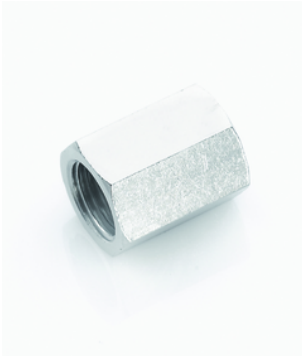

ITV	G	L	↳
401801	M5	10	8
401802	G1/8	15	13
401803	G1/4	22	17
401804	G3/8	22	22
401805	G1/2	26	27
401806	G3/4	34	32
401807	G1	38	41

## Muffe

Rund, blank  
Sleeve - round, uncoated

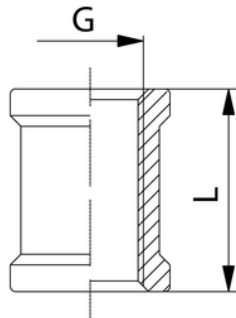

ITV	G	L
401815	G1/2	30
401816	G3/4	30
401817	G1	32
401818	G1 1/4	38
401819	G1 1/2	40
401820	G2	43
401821	G2 1/2	55
401822	G3	65

## Winkel 90°

Innen-Außen, blank  
Male-female elbow, uncoated

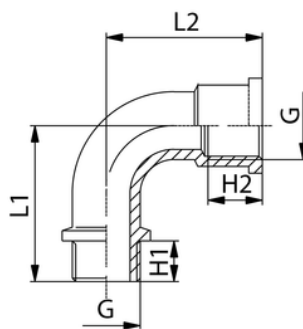

ITV	G	H2	L2	H1	L1
401643	G1/4	10	25	8	26
401644	G3/8	12	28	9	31
401645	G1/2	11	31	10	35
401646	G3/4	15	38	12	42
401647	G1	17	46	14	46
401648	G1 1/4	16	54	17	55
401649	G1 1/2	21	60	20	65
401650	G2	23	76	22	71

## Winkel 90°

Blank, Innen-Innengewinde  
Female elbow 90°, uncoated

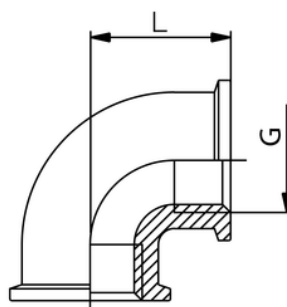

ITV	G	H	L1	L2
401633	G1/4	8	15	15
401634	G3/8	12	20	20
401635	G1/2	13	24	24
401636	G3/4	15	30	30
401637	G1	18	33	33
401638	G1 1/4	18	47	47
401639	G1 1/2	19	52	52
401640	G2	22,5	60	60

## T-Stück - blank

T-Stück - blank  
Female t - uncoated

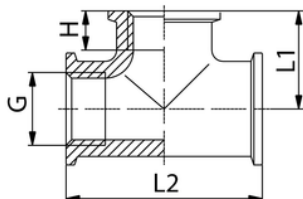

ITV	G	H	L1	L2
401613	G1/4	10	16,5	35
401614	G3/8	11	22,5	44
401615	G1/2	13	25,5	51
401616	G3/4	15	29,5	59
401617	G1	16	34	75
401618	G1 1/4	18	44	89
401619	G1 1/2	18	47	92
401620	G2	20	51	104

## Kreuzstück

Blank  
Female cross - uncoated

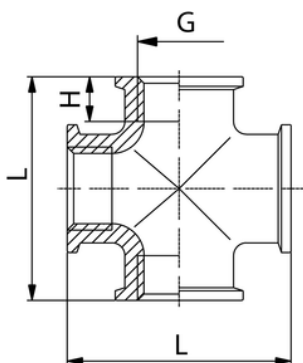

ITV	G	H	L
401605	G1/2	16,5	49
401606	G3/4	15,7	62
401607	G1	20,5	80

## Standrohrverschraubung

Blank  
Parallel straight adaptor, uncoated

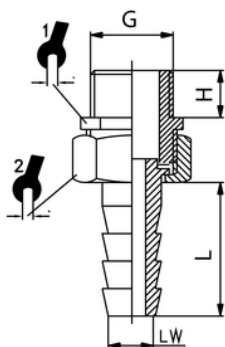

ITV	G	LW	H	L	∠	∠
401401	G3/8	10	9	22	22	27
401402	G1/2	13	10	23	27	34
401403	G3/4	19	10	24	34	42
401404	R1	25	15	32	42	50
401405	G1 1/4	32	16	38	50	55
401406	G1 1/2	38	18	47	55	58

# 1/3-Verschraubung

Hose connector 1/3

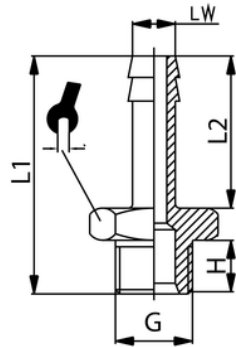

ITV	LW	G	H	L2	L1	↳
401002	3	M5	4,5	9	16	7
401012	6	G1/4	9	22	36	17
401014	9	G1/4	8	22	36	17
401015	10	G1/4	8,5	22	36	17
401017	13	G1/4	9	25	40	17
401022	6	G3/8	9	18	36	19
401024	9	G3/8	9	22	36	19
401027	13	G3/8	9	35	49	19
401032	6	G1/2	10	26	41	24
401034	9	G1/2	10	26	41	24
401037	13	G1/2	10	35	50	24
401039	19	G1/2	11	30	47	24
401043	13	G3/4	12	25	44	30
401045	19	G3/4	13	30	49	32
401048	25	G3/4	10	35	51	32
401053	25	G1	13	35	56	37
401056	32	G1	10,5	38,5	55	38
401063	32	G1 1/4	12	39	59	50
401066	38	G1 1/2	14	47	68	55
401073	50	G2	19	54	80	70

# Doppelnippel lösbar

Blank, konisch  
Detachable conical double nipple, uncoated

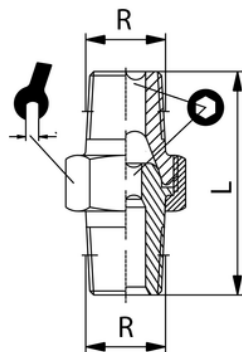

ITV	R	L	↳	O
306002	R1/8	27,5	15	5
306004	R1/4	33,5	19	6
306006	R3/8	37	22	8
306008	R1/2	45	27	12
306010	R3/4	54,5	36	14
306012	R1	65	46	19
306014	R1/8-R1/4	30,5	15	5
306015	R1/4-R3/8	34,5	19	6

## Doppelnippel lösbar, vernickelt

konisch  
Detachable conical double nipple, nickel-plated

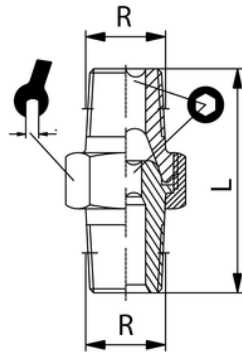

ITV	R	L	ø	O
306032	R1/8	27,5	15	5
306034	R1/4	33,5	19	6
306036	R3/8	37	22	8
306038	R1/2	45	27	12
306040	R3/4	54,5	36	14
306042	R1	65	46	19
306044	R1/8-R1/4	30,5	15	5
306045	R1/4-R3/8	34,5	19	6

## Winkel in Blockform 90°

Vernickelt, IG-AG  
Blockshaped elbow 90°

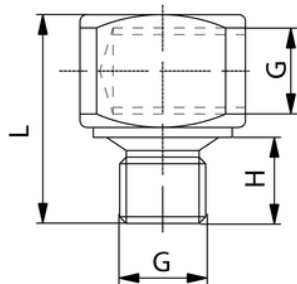

ITV	G	H	L
401901	M5	5	13
401902	G1/8	6,5	16,5
401903	G1/4	8	20

## T-Stück in Blockform

Vernickelt, 2x IG - 1x AG  
Blockshaped T - F. F. M.

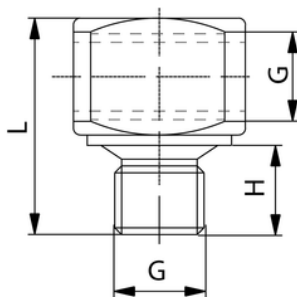

ITV	G	H	L
401922	G1/8	6,5	16,5
401923	G1/4	8	20



# Kontermutter

vernickelt  
Nut - nickel plated

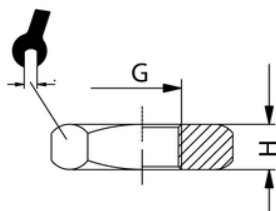

<b>ITV</b>	<b>G</b>	<b>H</b>	<b>t</b>
401362	G1/8	4,5	14
401363	G1/4	5	17
401364	G3/8	5,5	19
401365	G1/2	6	24
401366	G3/4	5	32
401367	G1	8	41
401368	G1 1/4	6	50
401369	G1 1/2	7	56
401370	G2	8	68