

IPSO-STECKVERSCHRAUBUNGEN MR

IPSO – PUSH-IN FITTINGS MR

FEATURES

- Stecksystem mit elastischer Spannzange aus Edelstahl
- Druckring aus Messing vernickelt für viele Einsatzzwecke
- Schlauchmontage mit einem Handgriff für Schläuche verschiedener Materialien
- kleine Baugröße und geringes Gewicht
- silikonfreie O-Ringe
- O-Ring in Dichtkehle – für raue Oberflächen
- modularer, flexibler Aufbau
- Innensechskant für leichte Montage
- *Push-in system with elastic clamp made of stainless steel*
- *Thrustring made of brass, nickel-plated, for many applications*
- *Tube assembly with one movement*
- *For tubes in various materials*
- *Small-scale and low weight*
- *Silicon-free O-rings*
- *O-ring in sealing channel – for rough surfaces*
- *Modular, flexible structure*
- *Hexagon socket for easy assembly*



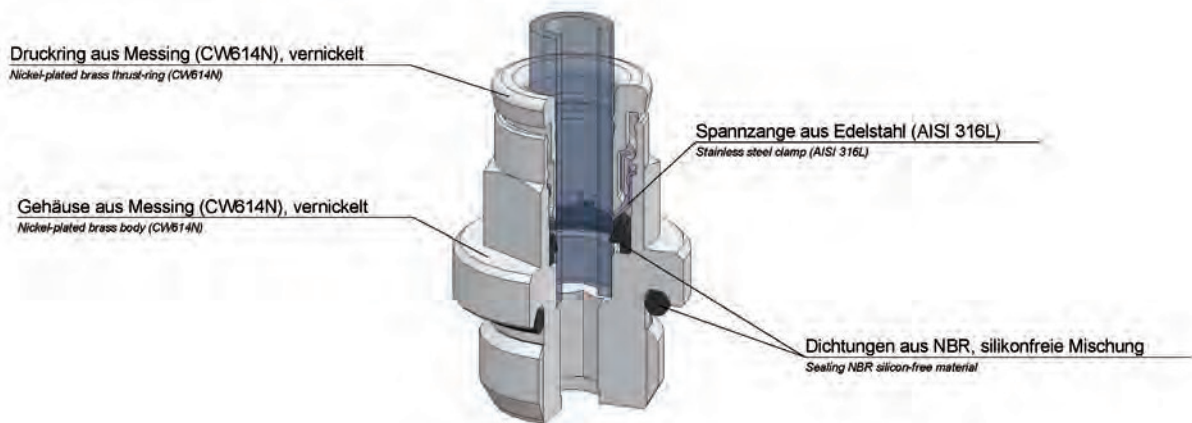

TECHNISCHE DATEN

Betriebstemperatur	-20°C bis +70°C -20°C bis +80°C	für Verschraubungen mit PVC-Dichtung für Vers. mit O-Ringen aus NBR
Betriebsdruck	bis 16 bar	abhängig vom Druckbereich des eingesetzten Schlauches
Vakuum	max 98%	
Werkstoffe	Gehäuse Messing vernickelt Dichtungen aus NBR Spannzange aus Edelstahl Druckring aus Kunststoff schwarz	CW614N und CW617N silikonfreie Mischung AISI 316L
Gewinde	zyl. Gew. DIN EN ISO 228 kon. Gew. DIN EN 10226 (DIN 2999) metr. Gew. DIN ISO 261	zylindrisch mit O-Ring-Abdichtung
Medium	geölte und ungeölte Druckluft	Medien, die mit den Materialien der Bauteile verträglich sind
Schläuche	für Leitungen nach ISO 14743 Toleranzen für Außen-Ø 4 bis 8: ±0,1 Toleranzen für Außen-Ø 10 bis 14: ±0,15 (PU) 10 bis 14: ±0,1 (PA)	empfohlene Materialien: PU, PA

TECHNICAL DATA

Operating temperature	-20°C to +70°C -20°C to +80°C	For fittings with PVC seal For fittings with NBR O-rings
Operating pressure	Up to 16 bar	Dependent on the pressure range of the tube used
Vacuum	max 98%	
Materials	Brass housing, nickel-plated NBR seals Stainless steel clamp Black plastic thrust ring	CW614N and CW617N Silicon-free AISI 316L
Thread	Cyl. thread, DIN EN ISO 228 Con. thread, DIN EN 10226 (DIN 2999) Metr. thread, DIN ISO 261	Cylindrical with O-ring seal
Medium	Lubricated and non-lubricated compressed air	Mediums which are compatible with the component materials
Tubes	For tubes in line with ISO 14743 Tolerances for external Ø 4 to 8: ±0.1 Tolerances for external Ø 10 to 14: ±0.15 (PU) 10 to 14: ±0.1 (PA)	Recommended materials, PU, PA

ipso 01

Gerade Einschraubverschraubung
Straight male adaptor (parallel)

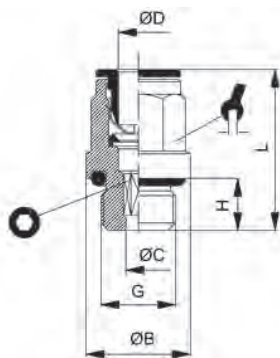

ITV	ØD	G	ØB	ØC	H	L	I	Ø
B200125	3	M3	5,5	1,5	3	13,5	Ø6,5	1,5
B200124	3	M5	8	2,1	4	15	Ø6,5	2,0
B200101	4	M5	8	2,5	4	20,5	Ø9	2,5
B200122	4	M6	9	2,6	7	23,5	Ø9	2,5
B200121	4	M7	10,5	3	6	22,5	9	3
B200127	4	M8	12	2,6	7	24,5	10	2,5
B200102	4	G1/8	13,5	2,6	5,5	19,5	9	2,5
B200103	4	G1/4	17	2,6	6,5	19,5	9	2,5
B200104	5	M5	8	2,6	4	22	Ø9,5	2,5
B200105	5	G1/8	13,5	4,2	5,5	22	10	4
B200106	5	G1/4	17	4,2	6,5	22	10	4
B200100	6	M5	8	2,5	4	22,5	Ø11	2,5
B200128	6	M6	9	2,6	5	23,5	Ø11	2,5
B200120	6	M7	11	3,6	6	24,5	Ø11	3,5
B200107	6	G1/8	13,5	4,2	5,5	23,5	11	4
B200108	6	G1/4	17	4,2	6,5	22,5	11	4
B200118	6	G3/8	20	4,2	9	25	13	4
B200109	8	G1/8	12,8	5,2	5,5	26,5	13	5
B200110	8	G1/4	17	6,2	6,5	23,5	13	6
B200111	8	G3/8	20	6,2	9	25	13	6
B200133	8	G1/2	23	6,2	11	31,5	13	6
B200129	10	G1/8	13,5	5,2	5,5	29	16	5
B200112	10	G1/4	16	7,3	6,5	27,5	16	7
B200113	10	G3/8	21	8,3	9	29,5	16	8
B200135	10	G1/2	24	8,3	11	31	16	8
B200119	12	G1/4	16	7,3	6,5	30	18	7
B200114	12	G3/8	21	10,3	9	31	18	10
B200115	12	G1/2	24	10,3	11	31,5	18	10
B200116	14	G3/8	21	10,3	9	34,5	21	10
B200117	14	G1/2	25	12,3	11	34,5	21	12
B200138	16	G1/2	24	12,3	11	37,5	24	12
B200140	16	G3/8	21	10,3	9	36	24	10

ipso 02

Manometerverschraubung
Straight female adaptor

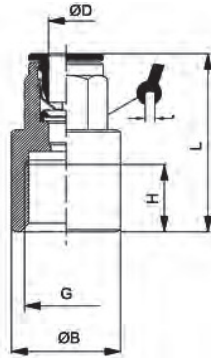

ITV	ØD	G	ØB	H	L	↳
B200200	4	M5	SW9	5	22,5	9
B200201	4	G1/8	12	6,5	26,5	9
B200202	4	G1/4	17	10	29,5	9
B200203	5	G1/8	12	6,5	27	10
B200204	5	G1/4	16	10	30	10
B200205	6	G1/8	12	6,5	27	11
B200206	6	G1/4	16	10	31	11
B200207	8	G1/8	12	6,5	28	13
B200208	8	G1/4	17	10	32	13
B200209	10	G1/4	16	10	32	16
B200210	10	G3/8	20	13	37,5	20
B200211	12	G1/4	20	13	40	20
B200212	12	G3/8	20	13	40	20
B200214	14	G1/4	20	10	37,7	20
B200215	16	G1/2	24	15	41	24

ipso 03

Gerader Verbinder
Straight connector



ITV	ØD1	ØD2	ØB1	ØB2	L
B200300	3	3	6,5	6,5	21
B200301	4	4	9	9	31
B200302	5	5	9,5	9,5	33
B200303	6	6	11	11	34
B200304	8	8	13	13	38
B200305	10	10	15	15	39
B200306	12	12	17	17	43,5
B200307	14	14	20	20	48
B200313	16	16	23	23	50
Reduziert / reduced					
B200308	6	4	11	9	34
B200309	8	6	13	11	39
B200310	10	8	15	13	40
B200311	12	10	17	15	42,5
B200312	14	12	20	17	45,5

ipso 04

Winkelverbinder
Elbow connector

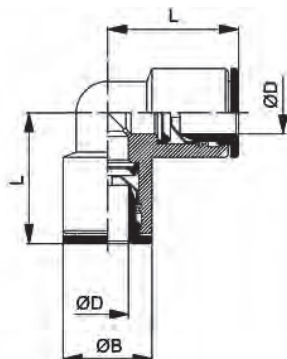

ITV	ØD	ØB	L
B200400	3	6	12
B200401	4	9	17,5
B200402	5	9,5	19
B200403	6	11	20
B200404	8	13	23
B200405	10	15	25
B200406	12	17	27,5
B200407	14	20	31
B200408	16	23	33

ipso 05

T-Verbinder
T-connector

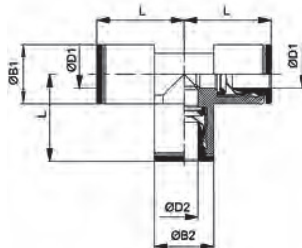

ITV	ØD1	ØD2	ØB1	ØB2	L
B200500	3	3	6,5	6,5	11,5
B200501	4	4	9	9	18
B200502	5	5	9,5	9,5	19
B200503	6	6	11	11	19,5
B200504	8	8	13	13	22,5
B200505	10	10	15	15	25
B200506	12	12	17	17	27
B200507	14	14	20	20	31
B200511	16	16	23	23	36
Reduziert / reduced					
B200508	6	4	11	9	19,5
B200509	8	6	13	11	22,5
B200510	10	8	15	13	25

ipso 013

Ringstück 1-fach
Single banjo body

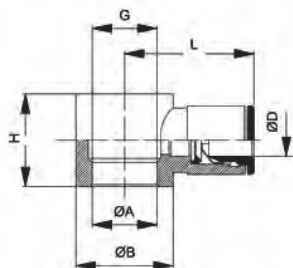

ITV	ØD	G	ØA	ØB	H	L
B201200	3	M3	3,6	SW6,5	6,5	12,5
B201201	4	M5	5	SW9	9	18,5
B201215	4	M6	6	SW9	9	19,5
B201202	4	G1/8	9,9	14	15	21
B201203	5	M5	5	SW9	9	19
B201204	5	G1/8	9,9	14	15	22,5
B201213	6	M5	5,1	SW9	10,5	19,5
B201205	6	G1/8	9,9	14	15	23
B201206	6	G1/4	13,3	18	17	24
B201207	8	G1/8	9,9	14	15	24,5
B201208	8	G1/4	13,3	18	17	26
B201209	8	G3/8	16,75	21	20	27,5
B201210	10	G1/4	13,3	18	17	27
B201211	10	G3/8	16,75	21	20	28,5
B201214	12	G1/4	13,3	18	17	28,5
B201212	12	G3/8	16,75	21	20	29,5

ipso 014

Ringstück 2-fach
Double banjo body

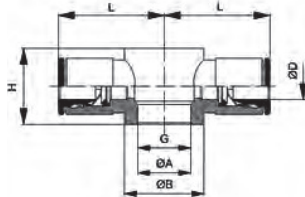

ITV	ØD	G	ØA	ØB	H	L
B201301	4	M5	5	7	9	18,5
B201302	4	G1/8	9,9	14	15	21
B201303	5	M5	5	9	9,5	19
B201304	5	G1/8	9,9	14	15	22,5
B201305	6	G1/8	9,9	14	15	23
B201306	6	G1/4	13,3	18	17	24
B201307	8	G1/8	9,9	14	15	24,5
B201308	8	G1/4	13,3	18	17	26
B201309	8	G3/8	16,75	21	20	27,5
B201310	10	G1/4	13,3	18	17	27
B201311	10	G3/8	16,75	21	20	28,5
B201312	12	G3/8	16,75	21	20	29,5

ipso 015

Winkeleinschraubverschraubung 360° drehbar
Complete single banjo (rotating under pressure) 360°

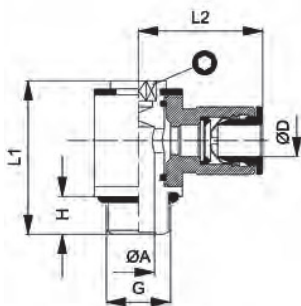

ITV	ØD	G	ØA	H	L1	L2	Ø
B201415	3	M3	1,5	3	16	14	2
B201416	3	M5	2	4	16,8	14	2
B201401	4	M5	2	4	16,8	18,5	2
B201402	4	G1/8	5,5	5,5	24,5	21,1	3
B201403	5	M5	2	4	16,8	19,5	2
B201404	5	G1/8	5,5	5,5	24,5	22,5	3
B201405	6	G1/8	5,5	5,5	24,5	23	3
B201407	6	G1/4	7,8	8	29,3	24,2	4
B201406	8	G1/8	5,5	5,5	24,5	24,5	3
B201408	8	G1/4	7,8	8	29,3	26	4
B201410	8	G3/8	10	9	34	27,5	5
B201409	10	G1/4	7,8	8	29,3	27	4
B201411	10	G3/8	10	9	34	28,5	5
B201414	12	G1/4	7,8	8	29,3	28,5	4
B201412	12	G3/8	10	9	34	29	5

ipso 016

T-Einschraubverschraubung 360° drehbar
Complete double banjo (rotating under pressure) 360°

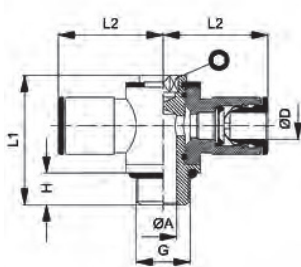

ITV	ØD	G	ØA	H	L1	L2	Ø
B201501	4	M5	2	4	16,8	18,5	2
B201502	4	G1/8	5,5	5,5	24,5	21,1	3
B201503	5	M5	2	4	16,8	19,5	2
B201504	5	G1/8	5,5	5,5	24,5	22,5	3
B201505	6	G1/8	5,5	5,5	24,5	23	3
B201507	6	G1/4	7,8	8	29,3	24,2	4
B201506	8	G1/8	5,5	5,5	24,5	24,3	3
B201508	8	G1/4	7,8	8	29,3	26	4
B201510	8	G3/8	10	9	34	27,5	5
B201509	10	G1/4	7,8	8	29,3	27	4
B201511	10	G3/8	10	9	34	28,5	5
B201512	12	G3/8	10	9	34	29,5	5

ipso 017

Winkelschwenkverschraubung
Complete single swivel banjo



ITV	ØD	G	ØB	H	L1	L2	↳
B11200	3	M3	7	2	12,5	12,5	ISW2
B11201	4	M5	SW9	3	17,5	18,5	8
B11215	4	M6	SW9	7	22	19,5	9
B11202	4	G1/8	14	5,5	28	21	14
B11203	5	M5	SW9	3	17,5	19,5	9
B11204	5	G1/8	14	5,5	28	22,5	14
B11213	6	M5	SW9	3	19,5	19,5	8
B11205	6	G1/8	14	5,5	28	23	14
B11206	6	G1/4	18	7	33	24	17
B11207	8	G1/8	14	5,5	28	24,5	14
B11208	8	G1/4	18	7	33	26	17
B11209	8	G3/8	21	7,5	36	27,5	19
B11210	10	G1/4	18	7	33	27	17
B11211	10	G3/8	21	7,5	36	28,5	19
B11214	12	G1/4	18	7	33	28,5	17
B11212	12	G3/8	21	7,5	36	29,5	19

ipso 018

T-Schwenkverschraubung
Complete double swivel banjo



ITV	ØD	G	ØB	H	L1	L2	↳
B11301	4	M5	7	3	17,5	18,5	8
B11302	4	G1/8	14	5,5	28	21	14
B11303	5	M5	7	3	17,5	19,5	8
B11304	5	G1/8	14	5,5	28	22,5	14
B11305	6	G1/8	14	5,5	28	23	14
B11306	6	G1/4	18	7	33	24	17
B11307	8	G1/8	14	5,5	28	24,5	14
B11308	8	G1/4	18	7	33	26	17
B11309	8	G3/8	21	7,5	36	27,5	19
B11310	10	G1/4	18	7	33	27	17
B11311	10	G3/8	21	7,5	36	28,5	19
B11312	12	G3/8	21	7,5	36	29,5	19

ipso 036

Winkeleinschraubverschraubung 2-fach 360° drehbar
Complete single banjo, doubled (rotating under pressure) 360°

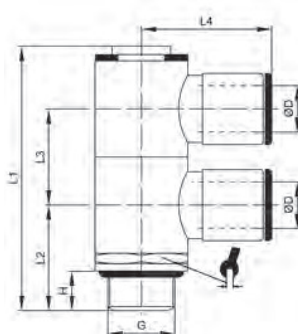

ITV	ØD	G	H	L1	L2	L3	L4	↳
B201422	4	G1/8	6	44	19	15	21	14
B201425	6	G1/8	6	44	19	15	23	14
B201426	6	G1/4	8	50	22,5	17	24	17
B201427	8	G1/8	6	44	19	15	24,5	14
B201428	8	G1/4	8	50	22,5	17	26	17
B201429	10	G1/4	8	50	22,5	17	27	17
B201424	12	G1/4	8	50	22,5	17	29	17

ipso 037

Winkleinschraubverschraubung 3-fach 360° drehbar
Complete single banjo, treble (rotating under pressure)
360°

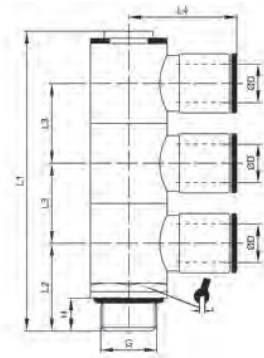

ITV	ØD	G	H	L1	L2	L3	L4	α
B201432	4	G1/8	6	59	19	15	21	14
B201435	6	G1/8	6	59	19	15	23	14
B201436	6	G1/4	8	67	22	17	24	17
B201437	8	G1/8	6	59	19	15	24,5	14
B201438	8	G1/4	8	67	22	17	26	17
B201439	10	G1/4	8	67	22	17	27	17
B201434	12	G1/4	8	67	22	17	28,5	17

ipso 010

Schottverschraubung
Bulkhead union

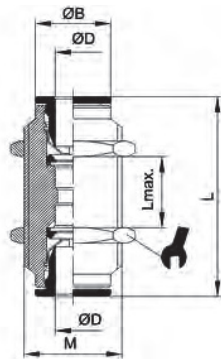

ITV	ØD	M	ØB	L max.	L	α
B201101	4	M10x1	9	15	32	13
B201102	5	M11x1	9,5	14	33	14
B201103	6	M14x1	11	11	33,5	17
B201104	8	M16x1	13	16	37	18
B201105	10	M17x1	15	19	39,5	20
B201106	12	M20x1	17	17	42	24
B201107	14	M22x1	20	21	46,5	25
B201108	16	M28x1,5	23	22	50	36

ipso 064

Winkel-Schottverschraubung
Bulkhead union elbow

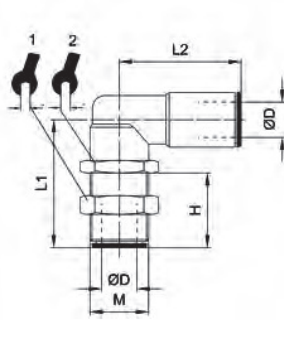

ITV	ØD	M	H	L1	L2	α	α
B206401	4	M10x1	13	26	20	13	13
B206403	6	M14x1	15	28	21,5	17	17
B206404	8	M16x1	17,5	30,5	24	18	18
B206405	10	M17x1	19,5	35	27	20	20
B206406	12	M20x1	23	41,5	29	24	24

ipso 025

Manometer-Schottverschraubung
Manometer bulkhead connector

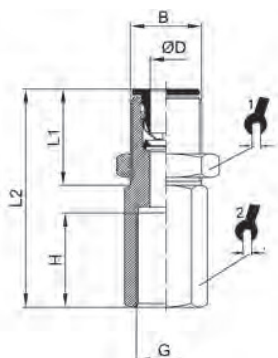

ITV	ØD	G	B	H	L1	L2	λ	λ
B202502	4	G1/8	M10x1	6,5	15	25	13	15
B202504	6	G1/8	M14x1	6,5	15,5	26,5	17	17
B202505	6	G1/4	M14x1	10	15,5	31	17	17
B202506	8	G1/8	M16x1	6,5	21,5	28,5	19	17
B202507	8	G1/4	M16x1	10	15,5	33	19	17

ipso 019

Winkeleinschraubverschraubung konisch
Threaded elbow adaptor conical



ITV	ØD	R	H	L1	L2	λ
B201901	4	R1/8	8	16,5	18,5	10
B201902	5	R1/8	8	16,5	19	10
B201903	6	R1/8	8	16,5	22,5	10
B201904	6	R1/4	11,5	22,5	24	12
B201905	8	R1/8	10	18,5	25	11
B201906	8	R1/4	12	22,5	25	11
B201907	10	R1/4	12	22	25	14

ipso 022

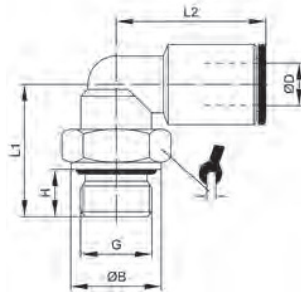
 Winkerverschraubung drehbar
 Rotary elbow male adaptor parallel

ITV	ØD	G	ØB	H	L1	L2	↳
B202221	3	M3	6	3	12,5	11	6
B202220	3	M5	8	4	13,5	11	8
B202200	4	M5	8	4	14,5	18	9
B202219	4	M6	9	5	16	18	9
B202216	4	M7	10	6	17	18	9
B202201	4	G1/8	13	5,5	19,5	20	13
B202202	4	G1/4	16	6,5	22,5	20	13
B202227	5	M5	8	4	14,5	20,5	9
B202228	5	G1/8	13	5,5	19,5	21	13
B202230	5	G1/4	16	6,5	22,5	21	13
B202215	6	M5	8	4	15	21	9
B202225	6	M6	9	5	16	21	9
B202217	6	M7	10	6	17	21	9
B202218	6	M12x1,25	16	8	24	21,5	13
B202222	6	M12x1,5	16	8	24	21,5	13
B202203	6	G1/8	13	5,5	19,5	21,5	13
B202204	6	G1/4	16	6,5	22,5	21,5	13
B202205	8	G1/8	13	5,5	20	23,5	13
B202206	8	G1/4	16	6,5	23	23,5	13
B202207	8	G3/8	20	9	26	23,5	13
B202208	10	G1/4	16	6,5	23	26,5	16
B202209	10	G3/8	20	9	28	26,5	16
B202224	10	G1/2	25	11	30	26,5	16
B202210	12	G1/4	16	6,5	29	29	16
B202211	12	G3/8	20	9	28,5	29	20
B202212	12	G1/2	25	11	33,5	29	20
B202213	14	G3/8	20	9	28,5	32	20
B202214	14	G1/2	25	11	33,5	32	20
B202268	16	G3/8	23	9	33	33,5	20
B202265	16	G1/2	23	11	38,0	33,0	20

ipso 022 k

Winkelverschraubung drehbar konisch
Rotary elbow male adaptor con.

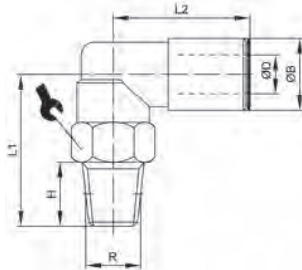

ITV	D	R	H	L1	L2	↳
B202251	4	R1/8	7	20	20	13
B202252	4	R1/4	11	25	20	14
B202253	6	R1/8	7	20	21,5	13
B202254	6	R1/4	11	25	21,5	14
B202255	8	R1/8	7	20,5	24	13
B202256	8	R1/4	11	25,5	24	14
B202257	8	R3/8	11	28,5	24	18
B202258	10	R1/4	11	26	27	16
B202259	10	R3/8	11	30	27	18
B202260	12	R3/8	11	32,5	29	20
B202261	12	R1/2	14	35,5	29	22
B202262	14	R3/8	11	35,5	32	22
B202263	14	R1/2	14	35,5	32	22

ipso 022 f

Drehbare Winkel-Aufschraubverschraubung
Rotary elbow fitting, female

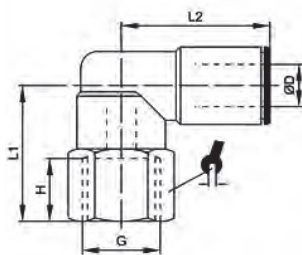

ITV	ØD	G	H	L1	L2	↳
B202801	4	G1/8	8	18	20	13
B202802	4	G1/4	11	22	20	16
B202803	6	G1/8	8	18	21,5	13
B202804	6	G1/4	11	22	21,5	16
B202805	8	G1/8	8	18,5	23,5	13
B202806	8	G1/4	11	22,5	23,5	16
B202808	10	G1/4	9	24	26,5	16

ipso 026

Winkeleinschraubverschraubung drehbar, lang
Rotary elbow male adaptor, long

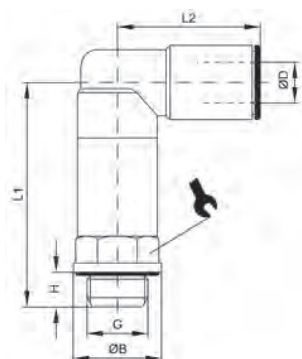

ITV	ØD	G	ØB	H	L1	L2	↳
B202600	4	M5	8	4	24	18	9
B202601	4	G1/8	13	5,5	32,5	20	13
B202602	4	G1/4	16	6,5	36,5	20	13
B202615	6	M5	8	4	24	21	9
B202603	6	G1/8	13	6	33	21,5	13
B202604	6	G1/4	16	6,5	36,5	21,5	13
B202605	8	G1/8	13	6	33	23,5	13
B202606	8	G1/4	16	6,5	37	23,5	13
B202607	8	G3/8	20	9	34,5	23,5	16
B202608	10	G1/4	16	6,5	37	26,5	16
B202609	10	G3/8	20	7	38	26,5	20

ipso 020

T-Verschraubung drehbar
Rotary tee parallel adaptor



ITV	ØD	G	ØB	H	L1	L2	↳
B202000	4	M5	8	4	16,5	19	9
B202001	4	G1/8	13	6	20	20	13
B202002	4	G1/4	16	6,5	22,5	20	13
B202003	6	G1/8	13	6	20	21,5	13
B202004	6	G1/4	16	6,5	22,5	21,5	13
B202005	8	G1/8	13	6	20	23,5	13
B202006	8	G1/4	16	6,5	22,5	23,5	13
B202007	8	G3/8	20	9	25,5	23,5	13
B202008	10	G1/4	16	6,5	23	26,5	16
B202009	10	G3/8	20	9	28	26,5	16
B202010	12	G1/4	16	8	30,5	29	16
B202011	12	G3/8	20	9	28,5	29	20
B202012	14	G1/2	25	11	33,5	32	20
B202016	14	G3/8	20	9	28,5	32	20

ipso 020 k

Drehbare T-Verschraubung, konisch
Rotary tee adaptor, conical

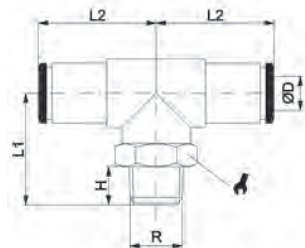

ITV	ØD	R	H	L1	L2	↳
B202051	4	R1/8	7	20,5	20,0	13
B202052	4	R1/4	11	25,0	20,0	14
B202053	6	R1/8	7	20,5	21,5	13
B202054	6	R1/4	11	25,0	21,5	18
B202055	8	R1/8	7	20,5	23,5	13
B202056	8	R1/4	11	25,0	23,5	14
B202057	8	R3/8	11	28,0	23,5	18
B202058	10	R1/4	11	26	26,5	13
B202059	10	R3/8	11	30,0	26,5	18
B202060	12	R3/8	11	32,5	28,5	20
B202061	12	R1/2	14	35,5	28,5	22
B202062	14	R3/8	11	32,5	32	20
B202063	14	R1/2	14	35,5	32	22

ipso 020 f

T-Verschraubung drehbar, Innengewinde
Rotary t-fitting, female

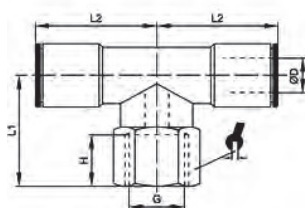

ITV	ØD	G	H	L1	L2	↳
B202901	4	G1/8	8	18	20	13
B202902	4	G1/4	11	22	20	16
B202903	6	G1/8	8	18	21,5	13
B202904	6	G1/4	11	22	21,5	16
B202905	8	G1/8	8	18	23,5	13
B202906	8	G1/4	11	22	23,5	16
B202908	10	G1/4	11	24	26,5	16

ipso 021

L-Verschraubung drehbar
Rotary parallel male L-adaptor

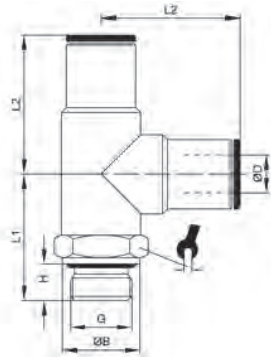

ITV	ØD	G	ØB	H	L1	L2	↳
B202100	4	M5	8	4	16,5	19	9
B202101	4	G1/8	13	5,5	19,5	20,5	13
B202102	4	G1/4	16	6,5	22,5	20,5	13
B202103	6	G1/8	13	6	19,5	21,5	13
B202104	6	G1/4	16	6,5	22,5	21,5	13
B202105	8	G1/8	13	6	19,5	23,5	13
B202106	8	G1/4	16	6,5	22,5	23,5	13
B202107	8	G3/8	20	9	25,5	23,5	13
B202108	10	G1/4	16	6,5	23	26,5	16
B202109	10	G3/8	20	9	28	27	16
B202110	12	G1/4	16	8	23	29	16
B202111	12	G3/8	20	9	28	29	16
B202113	12	G1/2	25	11	30,0	28,5	20
B202114	14	G3/8	20	9	28,5	32,0	20
B202112	14	G1/2	25	11	33	33	20

ipso 021 k

Drehbare L-Verschraubung, konisch
Rotary L-adaptor, conical



ITV	ØD	R	H	L1	L2	↳
B202152	4	R1/4	11	25,0	20,5	14
B202153	6	R1/8	7	20,5	21,5	13
B202154	6	R1/4	11	25,0	21,5	14
B202155	8	R1/8	7	20,5	23,5	13
B202156	8	R1/4	11	25,0	23,5	14
B202157	8	R3/8	11	28,0	23,5	18
B202158	10	R1/4	11	26,0	26,5	16
B202160	12	R3/8	11	30,0	28,5	18
B202161	12	R1/2	14	33,0	28,5	22
B202162	14	R3/8	11	32	33	20
B202163	14	R1/2	14	35	33	22

ipso 060

Gewindeanschluss-Stecker lang
Adapter parallel, long

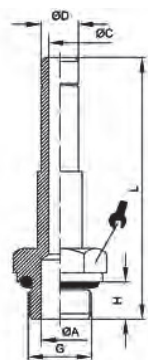

ITV	ØD	G	ØC	ØA	H	L	↳
206102	4	G1/8	2	6	6	39	13
206107	6	G1/8	4	6	6	43,5	13
206108	6	G1/4	4	7,5	6,5	44,5	13
206109	8	G1/8	6	6	5,5	47	13
206110	8	G1/4	6	7,5	6,5	48	13
206112	10	G1/4	8	8	8	55,5	13

ipso 08

Reduzier-Stecker
Reducer

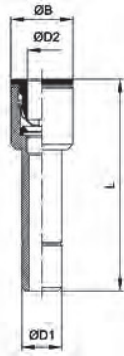

ITV	ØD1	ØD2	ØB	L
B200801	5	4	9	33
B200802	6	4	9	30
B200803	6	5	9,5	35,5
B200804	8	4	9	32
B200805	8	5	10	32,5
B200806	8	6	11	33
B200807	10	6	11	37,5
B200808	10	8	13	38,5
B200809	12	4	13	40
B200810	12	6	13	40
B200811	12	8	13	39
B200817	12	10	15	41
B200812	14	4	9	43,5
B200813	14	6	11	43,5
B200814	14	8	13	43,5
B200815	14	10	15	43,5
B200816	14	12	17	44
B200820	16	12	17	44,5
B200819	16	14	20	47

ipso 08 E

Erweiterung
Extension

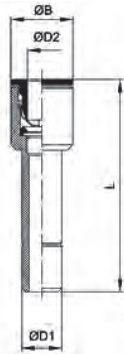

ITV	ØD1	ØD2	ØB	L
B200901	4	6	11	35
B200902	6	8	13	38,5

ipso 047

Winkelsteckanschluss
Elbow connector

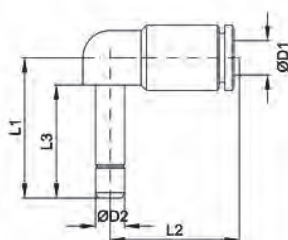

ITV	ØD1	ØD2	L1	L2	L3
B204701	4	4	20	17,5	16
B204703	6	6	26,5	19,5	18
B204704	8	8	31	23	19,5
B204714	8	8	45	24	34
B204705	10	10	35,5	24	24
B204706	12	12	41	27	25
Reduziert / reduced					
B204707	4	6	29	20	18
B204708	6	8	30,5	21,5	19,5

ipso 047 L

Winkelsteckanschluss, lang
Elbow connector, long

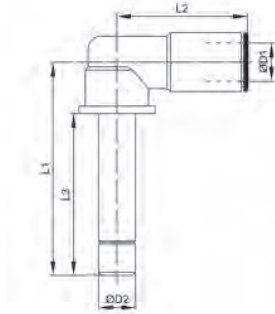

ITV	ØD1	ØD2	L1	L2	L3
B204711	4	4	31,5	19	23
B204713	6	6	43	21	32
Reduziert / reduced					
B204717	4	6	43	20	32
B204718	6	8	45	21	34

ipso 027

Einpress-Patrone, blank
Cartridge, blank

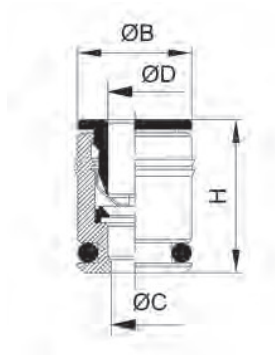

ITV	ØD	ØC	ØB	H
B202701	4	2,9	9,2	16,5
B202703	6	5	11,2	17,5
B202704	8	7	13,2	19,5
B202705	10	8	15,2	21

ipso 044

Schlauchverschluss
Plug

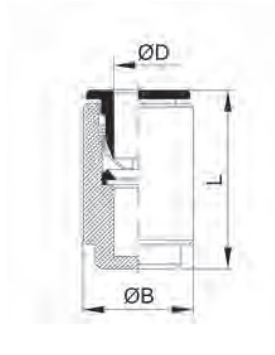

ITV	ØD	ØB	L
B204401	4	9	16
B204403	6	11	17,5
B204404	8	13	20,5
B204405	10	15	19,5
B204406	12	17	22,2