

Standard executions		
Version	Symbol	Type
Magnetic		MDMX
Magnetic with adjustable cushionings (bore from 20 to 25 mm)		MDMAX

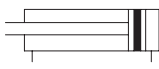
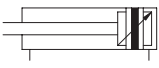

II 2Gc IIC T5  
II 2Dc T100°C

On request, they can be supplied according to 2014/34/EU - ATEX

Options	Suffix
Through rod	P
Seals FKM -20°C ÷ +150°C	V
Special version on request	/ S

The options can be combined (when this is possible).

Series of stainless steel cylinders conforming to ISO 6432 standards.

The heads are connected with the tube through rolling; this guarantees perfect tightening.

The cushionings are in nitrile rubber to relieve the impact of the piston.

One or more magnetic reed switches can be applied to the magnetic type.

For the magnetic reed switches type ASV see from page 1.110.1.

For mounting accessories see from page 5.30.1.

For rod clevis see from page 5.20.1.

How to order: 20/50 MDMXP

20	/	50	MDMX	P
Bore	/	Stroke	Type	Option

Technical data	
Fluid	Compressed filtered air with or without lubrication. Lubrication, if started, must be continued.
Pressure	max 10 bar
Temperature range	-20°C ÷ +80°C (standard)      -20°C ÷ +150°C (V)
Materials	Heads: Stainless steel AISI 316 Barrel: Stainless steel AISI 304 Rod: Stainless steel AISI 316 Seal: Polyurethane - Bronze bushing: Sintered bronze - Piston: brass

Bore (mm)	Corse standard (mm)	Maximum stroke (mm)
16	10, 25, 50, 80, 100, 125, 160, 200, 250, 320, 400, 500	1000
20		
25		

See page 1.1.3 to calculate the cylinder force.  
Seal kits not available for these cylinders.

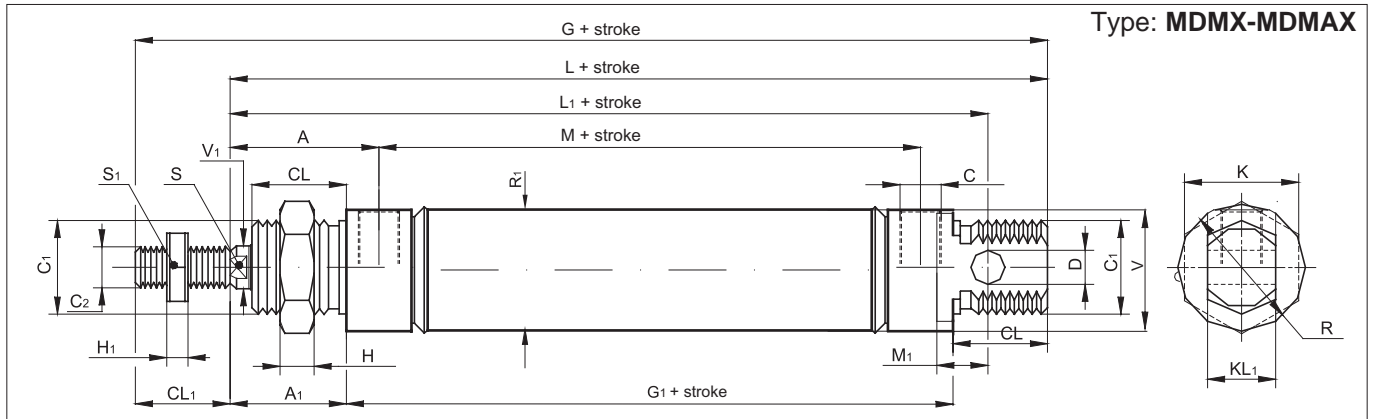

Ø mm	C2	V1	C1	R	KL1	R1	V	D	CL1	L1	L	M	G1	A1	CL	A	M1	S	C	G	K	H	H1	S1
16	M6	6	M16x1,5	20	12	17,27	19	6	16	82	96	46	56	22	18	27	9	5	M5	112	24	6	3	10
20	M8	8	M22x1,5	27	16	21,27	25,5	8	20	95	111	51	67	24	20	32	12	7	1/8"	131	27	8	4	13
25	M10x1,25	10	M22x1,5	30	16	26,5	28	8	22	104	118	52	67	29	22	37	12	9	1/8"	140	27	8	5	17

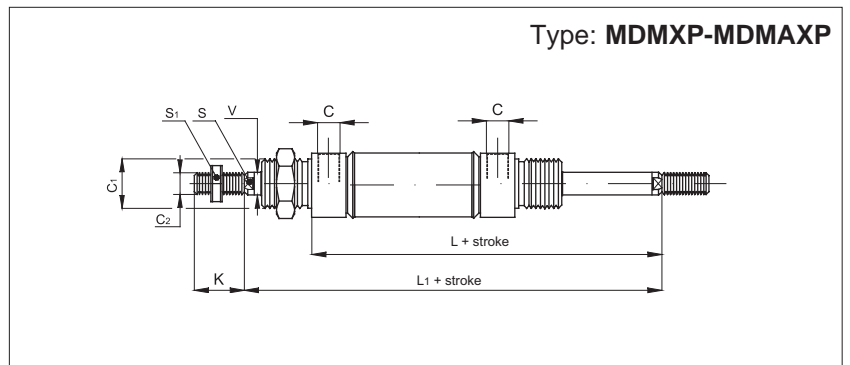
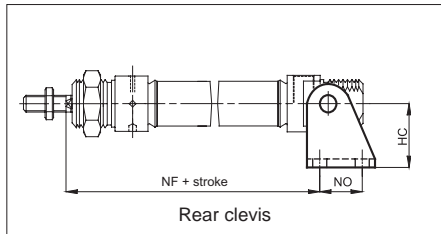
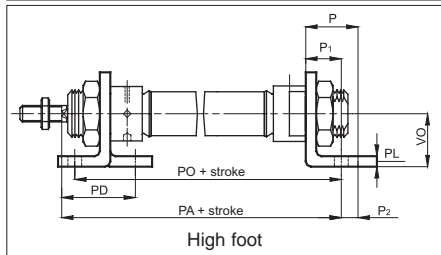
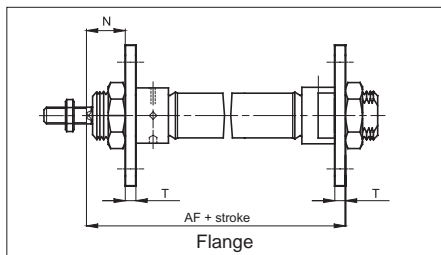

Ø mm	L	L1	C	C1	C2	S	S1	V	K
16	74,5	96,5	M5	M16x1,5	M6	5	10	6	16
20	92	116	1/8"	M22x1,5	M8	7	13	8	20
25	97	125	1/8"	M22x1,5	M10x1,25	9	17	10	22

Ø mm	AF	HC	P	P1	P2	PA	PD	PL	PO	T	VO	N
16	82	27	20	14	6	92	32	4	84	4	20	18
20	97	30	25	17	8	109	36	5	102	5	25	19
25	102,5	30	25	17	8	114,5	40	5	103,5	5	25	23

For dimensions and codes of the accessories see page 5.30.1