

Standard executions		
Version	Code	Item
Bore 25 mm	075053	25PPE
Bore 32 mm	075054	32PPE
Bore 40 mm	075055	40PPE
Bore 50 mm	075056	50PPE
Bore 63 mm	075057	63PPE



Series of pneumatic parallel hand grips with 3 fingers available in 5 different sizes.

They are standard magnetic with groves on the body allowing the direct mounting of magnetic reed switches.

For magnetic reed switch type ASC see from page 1.110.1.

How to order : 32PPE

32	PPE
Bore	Type

Technical data					
Type	25PPE	32PPE	40PPE	50PPE	63PPE
Fluid	Compressed filtered air with or without lubrication. Lubrication, if be used, must be continuous				
Pressure	1,5 ÷ 7 bar				
Temperature range	0 °C ÷ +80° C				
Max. operation frequency	180 cycle / min.				
Lubrication	Piston: with or without lubrication				
	Levers: lubrication is required on moving parts				
Stroke of open/close (mm)	6	8	8	12	16
Ports	M5				

Materials

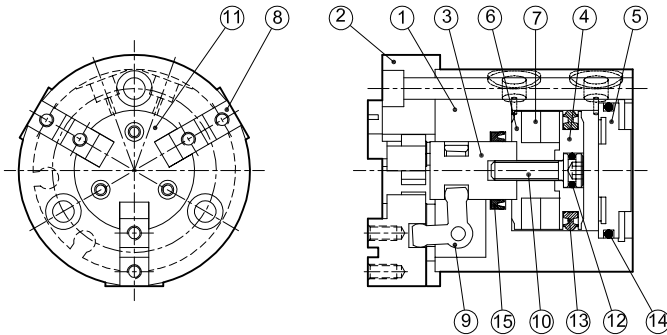

N.	Component	Material
1	Body	Aluminium
2	Front head	Aluminium
3	Piston rod	Steel
4	Piston	Aluminium
5	End cover	Aluminium
6	Magnet holder	Aluminium
7	Magnet	Plastic magnet
8	Fingers	Steel
9	Action lever	Steel
10	Screw	Stainless steel
11	Finger cover	Stainless steel
12	O-ring	NBR
13	Piston seals	NBR
14	End cover O-ring	NBR
15	Piston rod seals	NBR

Gripping forces

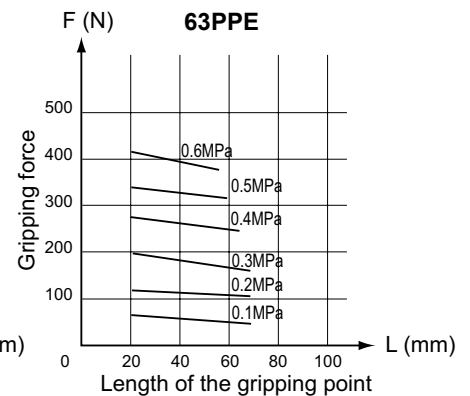
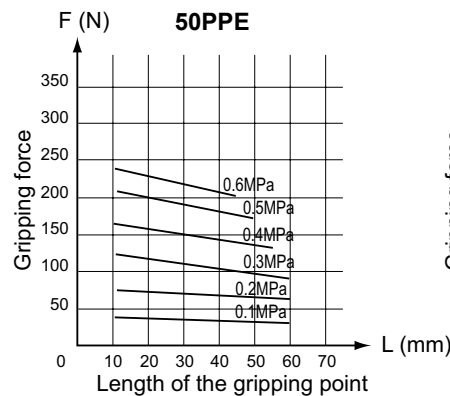
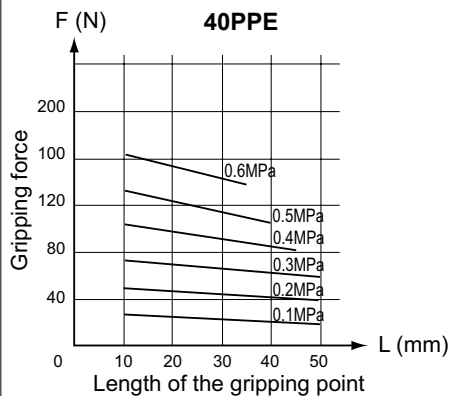
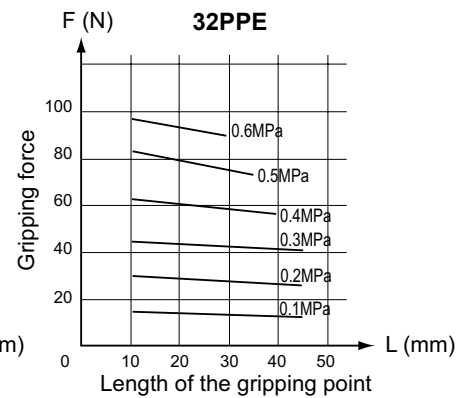
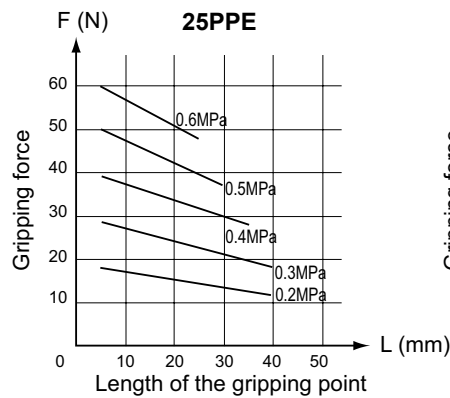
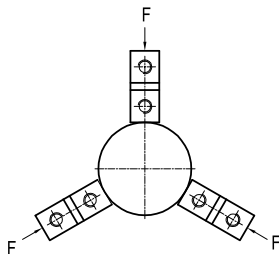
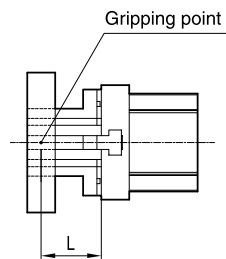
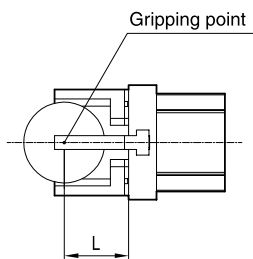

Type: **25PPE**

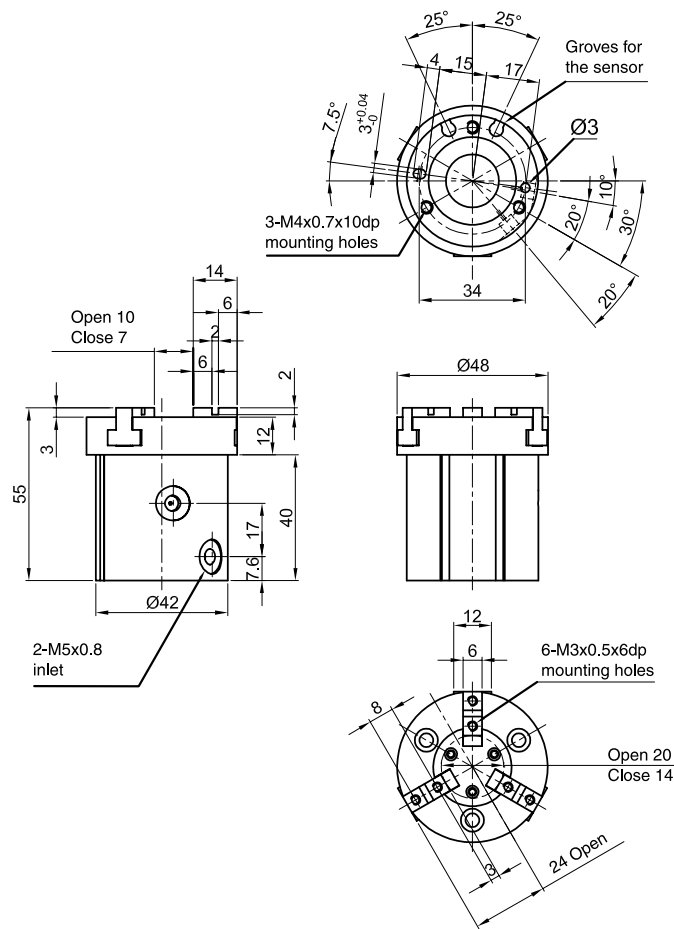

Type: **32PPE**

